



FORGATTI
v a l e • a l u m í n i o s

CATÁLOGO
PERFIS DE ALUMÍNIO

LINHA
CONVENCIONAL

MAIO / 2016

Índice

PERFIL	PESO (KG/M)	PÁGINA
A-022	0,297	06
A-026	0,750	20
A-034	0,500	17
A-041	0,730	20
A-046	1,040	22
A-047	0,560	14
A-048	0,710	13
A-058	0,203	41
A-072	1,210	38
A-081	1,300	22
A-084	0,580	17
A-087	0,318	08
A-096	1,860	38
A-103	1,545	27
A-104	0,870	28
A-139	1,033	15
A-144	0,814	23
A-194	0,653	13
A-195	0,686	13
A-201	0,526	14
A-207	0,591	14
A-1730	1,510	28
BX-040	0,316	06
BX-085	0,181	09
BX-087	0,154	09
BX-088	0,203	09
BX-089	0,251	09
BX-090	0,208	09
BX-091	0,200	09
BX-097	0,495	09
BX-140	0,504	09
BXL-085	0,190	07
BXL-087	0,168	07
BXL-089	0,257	07
BXL-090	0,216	07
BXL-091	0,216	07
BLX-097	0,505	07
BXL-3918	0,506	07
CA-006	1,156	04
CA-009	1,616	04
CA-010	0,385	04
CA-011	0,286	04
CA-013	0,121	04
CA-014	0,097	04

PERFIL	PESO (KG/M)	PÁGINA
CA-060	0,276	03
CA-098	0,371	03
CA-104	0,304	03
CA-110	0,209	03
CA-113	0,461	03
CA-125	0,528	03
CA-126	0,487	03
CA-151	0,309	03
CA-200	0,216	03
CA-709	0,551	03
CG-087G	0,427	36
D-042	1,555	34
D-053	1,300	32
D-054	0,970	32
D-055	0,580	35
D-059	0,845	32
D-069	1,110	34
D-070	0,263	36
D-078	0,794	34
D-079	0,645	34
D-080	0,534	35
D-081	0,667	35
D-082	0,356	36
D-095	0,550	39
D-102	0,629	35
D-103	0,800	34
D-143	1,249	39
D-777	0,974	35
D-778	0,897	35
E-117	0,290	06
E-150	0,285	24
E-256	0,234	08
E-277	0,509	10
E-362	0,636	36
E-363	1,043	36
E-364	0,499	36
E-365	0,656	36
E-482	0,884	10
E-484	0,650	12
E-491	1,030	18
ES25-548	0,283	16
I-083	0,300	06
I-090	0,300	17
I-105	0,263	16

PERFIL	PESO (KG/M)	PÁGINA
I-154	0,230	08
I-155	0,390	08
I-173	0,434	29
I-185	0,092	39
I-186	0,097	39
I-334	0,235	06
L-213	0,697	05
L-332	0,210	24
L-387	0,220	16
L-473	0,192	29
L-519	0,300	23
L-521	0,362	29
L-522	0,470	29
L-579	1,038	05
LB-038	1,060	33
P-027	0,198	42
P-064	0,400	24
P-068	0,694	20
P-075	0,607	21
P-078	0,772	20
P-084	0,561	21
P-120	0,535	24
P-121	0,535	24
P-140	0,520	14
P-145	0,491	17
P-146	0,491	17
P-147	0,366	16
P-148	0,705	21
P-149	0,660	21
P-151	0,610	14
P-152	0,660	14
P-153	0,604	15
P-157	1,355	11
P-165	1,244	22
P-166	0,425	17
P-167	0,425	17
P-192	0,730	30
P-193	0,740	30
P-194	0,862	27
P-227	0,535	42
P-248	2,201	25
P-250A	1,172	28
P-253	0,595	30
P-256	0,497	42

PERFIL	PESO (KG/M)	PÁGINA
P-258	1,187	19
P-264	0,219	23
P-267	1,016	26
P-268A	1,373	28
P-269	0,880	23
P-270	0,813	23
P-273	0,618	23
P-274	0,976	11
P-279	1,275	27
P-280	0,870	29
P-281	0,843	20
P-282	0,832	20
P-318	0,653	13
P-319	0,743	15
P-358	0,973	22
P-370	0,745	13
P-371	0,775	13
P-412	0,558	15
P-413	0,813	16
P-414	0,699	15
P-416	0,591	15
P-417	0,744	21
P-419	0,726	24
P-570	1,257	12
P-574	0,634	17
P-578	1,504	19
P-4261	1,137	26
P-4262	1,211	26
P-4263	1,292	26
PB-2212	0,427	40
PC-010	1,585	35
POLI-001	0,278	40
POLI-002	0,171	40
POLI-003	0,136	40
POLI-004	0,311	40
POLI-010	0,184	40
RA-006	0,168	05
RA-007	0,156	05
RA-013	0,267	05
RA-014	0,214	04
RA-029	0,369	05
RA-043	0,248	04
RA-092	0,160	04
RA-111	0,173	05
RA-130	0,166	05
RA-163	0,193	04

PERFIL	PESO (KG/M)	PÁGINA
RA-169	0,431	05
RA-347	0,185	04
T-123	0,162	39
T-214	0,210	05
TM-1434	0,295	41
TM-1440	0,379	41
TM-1497	0,320	41
TM-1498	0,347	41
TM-1499	0,320	41
TM-1500	0,590	41
TM-1712	0,176	42
TM-1857	0,290	41
TM-1858	0,214	42
TM-2070	0,208	42
TM-5486	0,212	42
U-351	0,170	37
U-352	0,725	37
U-398	0,200	07
U-425	0,145	11
U-482	0,115	24
U-495	0,165	39
U-496	0,380	39
U-497	0,504	39
U-498	0,285	39
U-522	0,100	16
U-611	0,225	29
U-615	0,380	38
U-621	0,265	38
U-654	0,186	08
U-679	0,180	23
U-681	0,131	11
U-683	0,154	16
U-689	0,168	19
U-874	0,163	16
U-877	0,351	38
U-878	0,432	38
U-990	0,653	37
U-1002	0,186	08
U-1056	0,187	06
U-1076	0,200	29
U-1091	0,740	39
U-1092	0,444	39
U-1098	0,494	37
U-1242	0,600	06
U-1243	0,534	08
U-1244	0,240	06

PERFIL	PESO (KG/M)	PÁGINA
U-1245	0,183	08
U-4848	1,308	37
VA-012	0,276	31
VA-017	0,266	31
VZ-060	0,397	31
VZ-063	0,263	31
Y-105	0,222	06
Y-106	0,222	06
Y-107	0,212	06
Y-113	0,345	24
Y-120	0,260	16
Y-126	0,260	16
Y-131	0,506	21
Y-140	0,428	24
Y-181	0,580	30
Y-195	0,480	14
Y-196	0,485	14
Y-197	0,298	17
Y-260	0,816	12
Y-271	0,610	27
Y-273	0,705	30
Y-308	0,302	08
Y-310	0,243	08
Y-311	0,232	08
Y-312	0,516	42
Y-335	0,841	33
Y-350	0,984	25
Y-351	0,440	30
Y-355	0,871	33
Y-429	0,685	33
Y-689	0,301	32
Z-033	0,350	37
Z-063	0,325	37
Z-074	0,260	11
Z-082	0,340	19
Z-114	0,564	11
Z-174	0,726	10
Z-175	0,569	10
Z-176	0,845	10
Z-181	0,564	18
Z-182	0,662	18
Z-183	0,989	18
Z-194	0,348	32
Z-201	0,250	31
Z-203	0,325	31
Z-248	0,298	32
Z-267	0,729	10

CONTRAMARCO E ARREMATES	PÁGINA 03
BOX LISO	PÁGINA 06
BOX BX LISO	PÁGINA 07
BOX FRISADO	PÁGINA 08
BOX BX FRISADO	PÁGINA 09
LINHA 25	PÁGINA 10
LINHA 30	PÁGINA 18
LINHA 42	PÁGINA 25
VENEZIANAS	PÁGINA 31
BRISES	PÁGINA 32
LAMBRI	PÁGINA 33
TUBOS E TRILHOS	PÁGINA 34
FACHADA CORTINA	PÁGINA 38
GUARDA CORPO / DIVERSOS	PÁGINA 39
POLICARBONATO	PÁGINA 40
TELA MOSQUITEIRA	PÁGINA 41

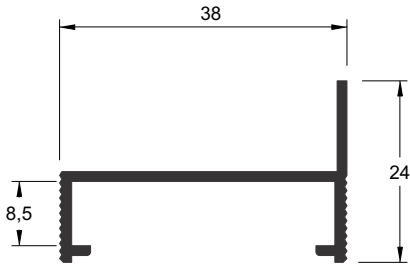

CA-060

0,276 kg/m

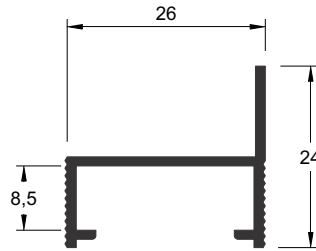

CA-200

0,216 kg/m

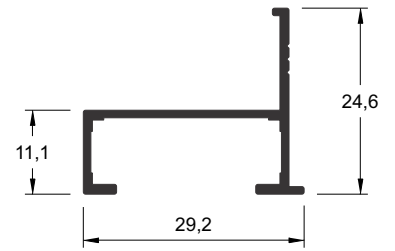

CA-110

0,209 kg/m

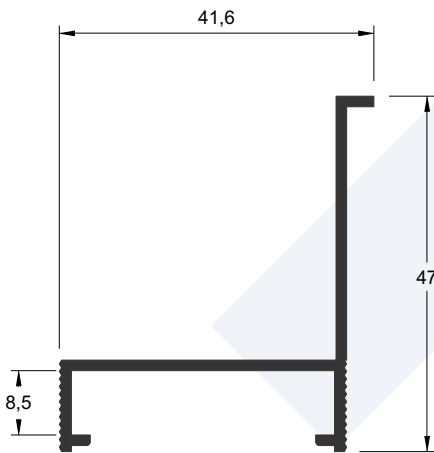

CA-098

0,371 kg/m

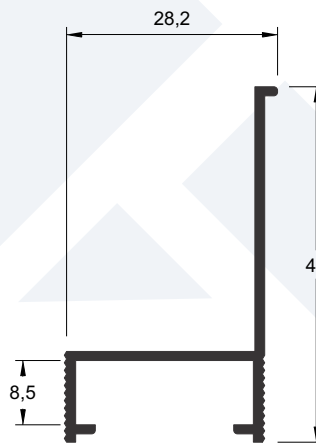

CA-151

0,309 kg/m

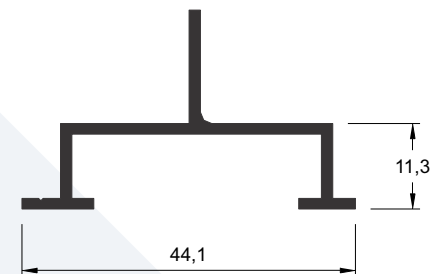

CA-104

0,304 kg/m

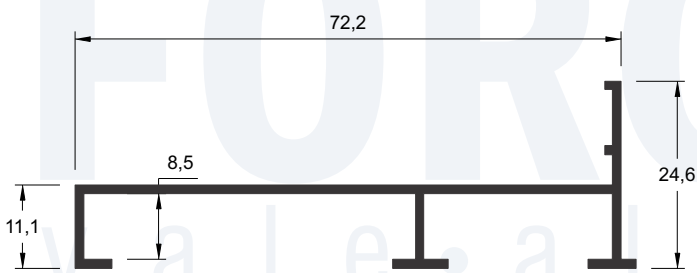

CA-113

0,461 kg/m

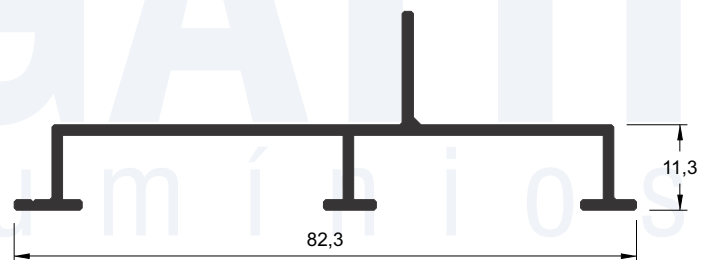

CA-125

0,528 kg/m

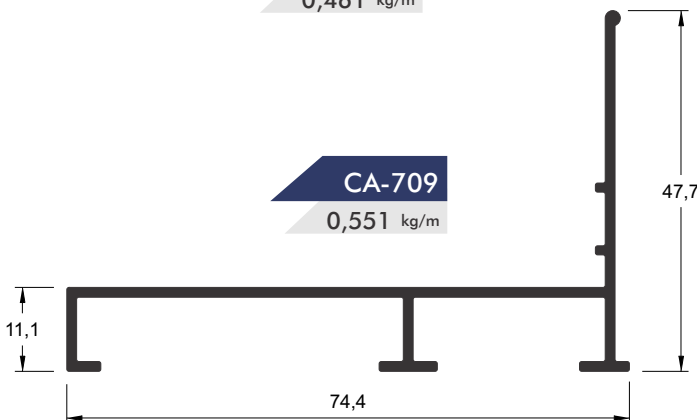

CA-709

0,551 kg/m

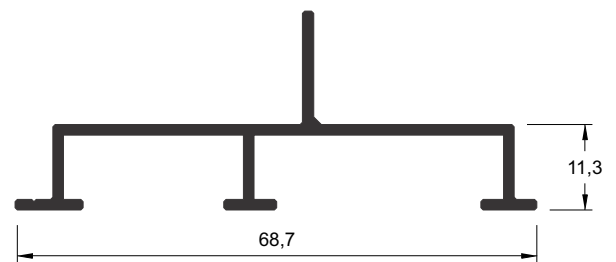

CA-126

0,487 kg/m

Linha Convencional

Contramarco e Arremates



CA-006

1,156 kg/m

49,7



CA-009

1,616 kg/m

64

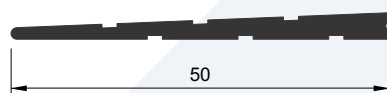

CA-011

0,286 kg/m

50

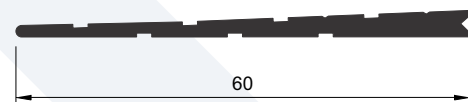

CA-010

0,385 kg/m

60



RA-347

0,185 kg/m

9,7

37

12



RA-163

0,193 kg/m

37

12



RA-043

0,248 kg/m

47,2

16

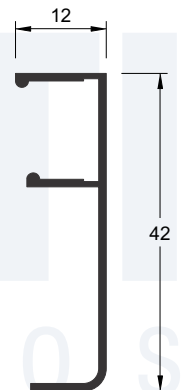

RA-014

0,214 kg/m

42

12

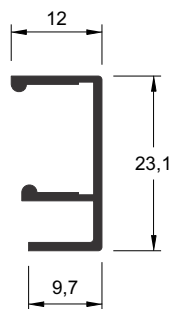

RA-092

0,160 kg/m

23,1

12

9,7



CA-014

0,097 kg/m

12,3



CA-013

0,121 kg/m

12,5

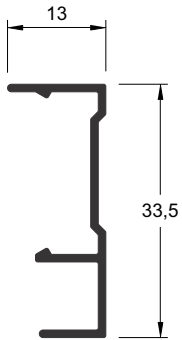

RA-111
0,173 kg/m

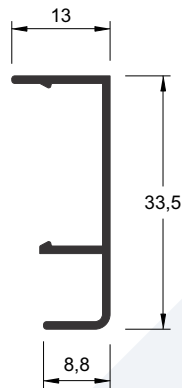

RA-130
0,166 kg/m

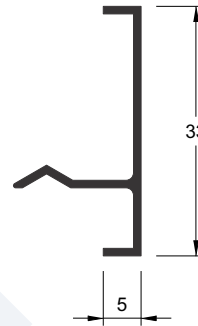

RA-007
0,156 kg/m

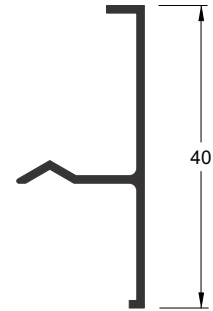

RA-006
0,168 kg/m

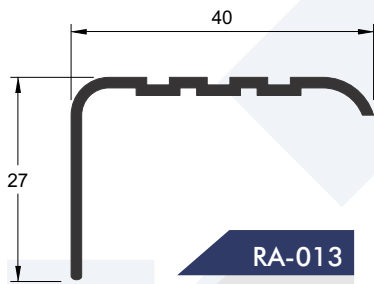

RA-013
0,267 kg/m



L-213
0,697 kg/m

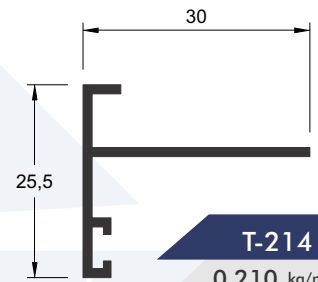

T-214
0,210 kg/m



CA-174
0,409 kg/m

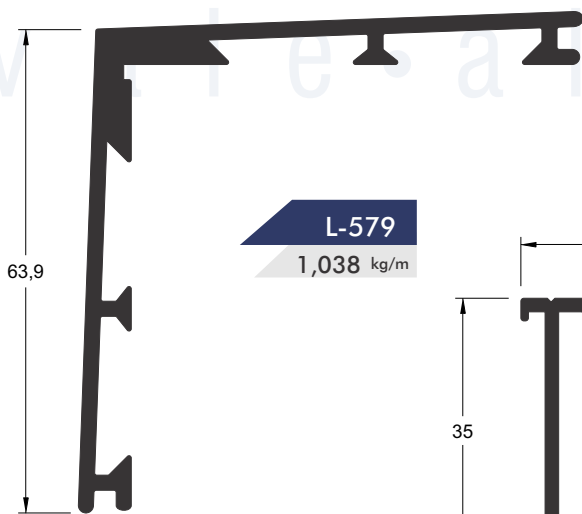

L-579
1,038 kg/m

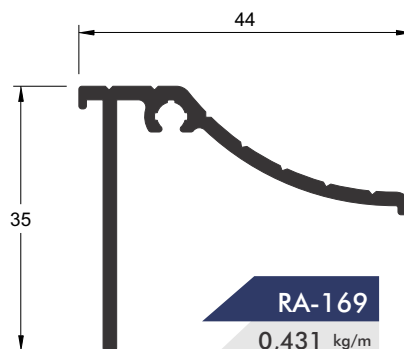

RA-169
0,431 kg/m

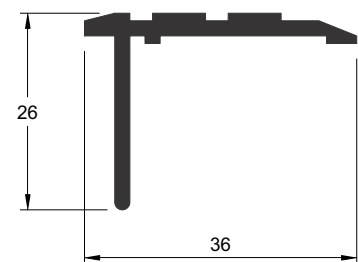

RA-029
0,369 kg/m

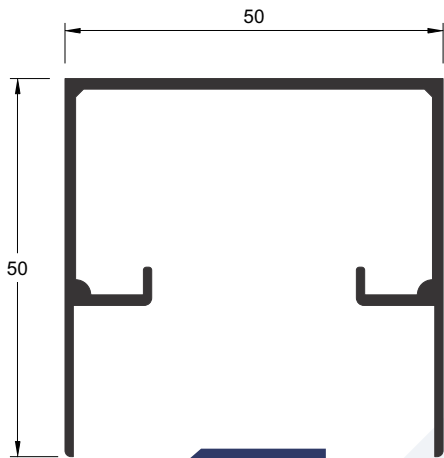

U-1242
0,600 kg/m

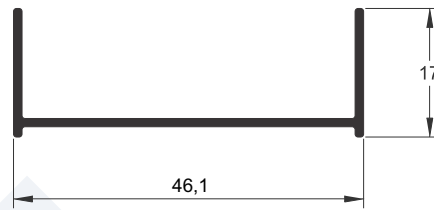

U-1244
0,240 kg/m

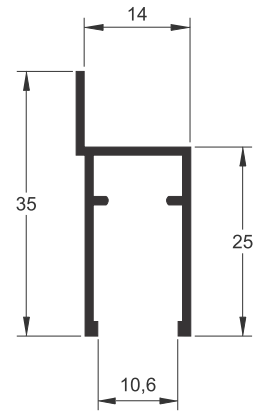

Y-106
0,222 kg/m

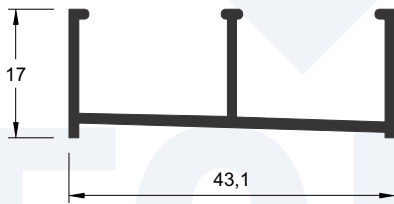

E-117
0,290 kg/m

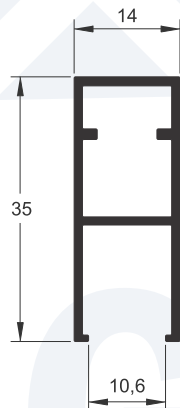

A-022
0,297 kg/m

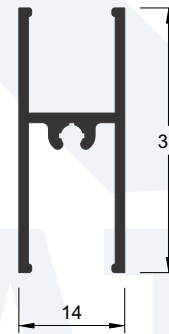

I-083
0,300 kg/m

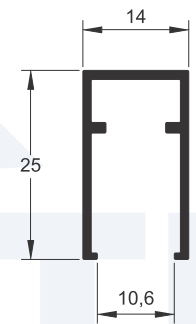

U-1056
0,187 kg/m

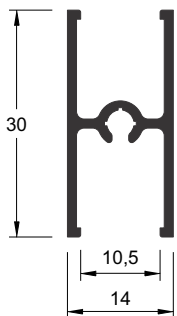

I-334
0,235 kg/m

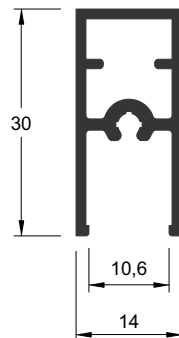

BX-040
0,316 kg/m

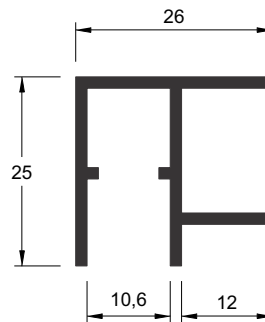

Y-105
0,222 kg/m

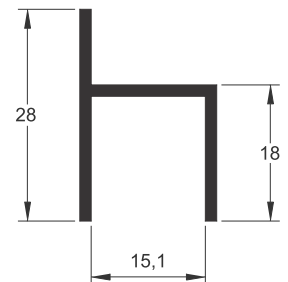

Y-107
0,212 kg/m

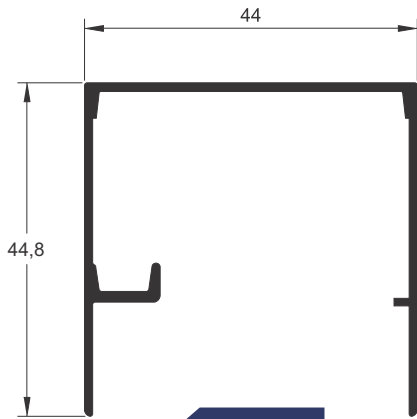

BXL-097
0,505 kg/m

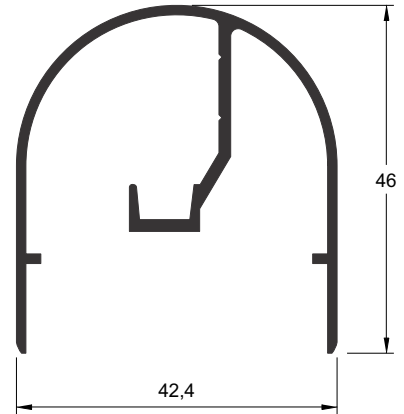

BXL-3918
0,506 kg/m

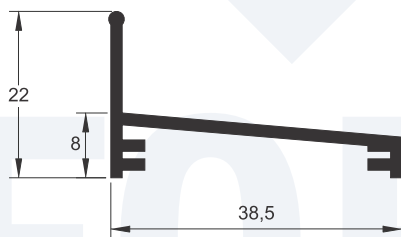

BXL-089
0,257 kg/m

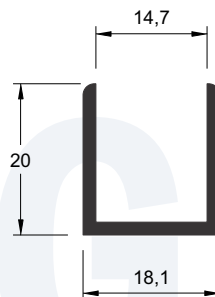

U-398
0,200 kg/m

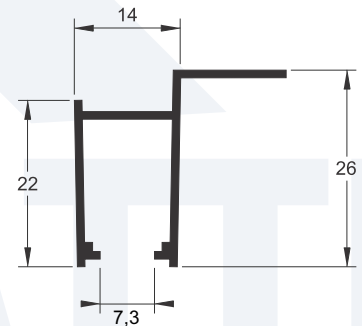

BXL-091
0,216 kg/m

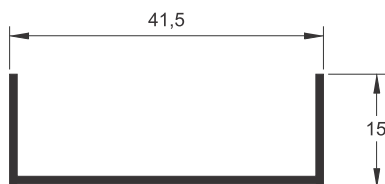

BXL-085
0,190 kg/m

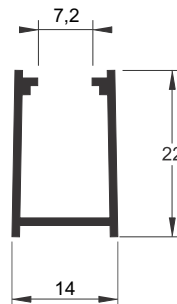

BXL-087
0,168 kg/m

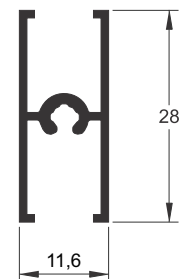

BXL-090
0,216 kg/m

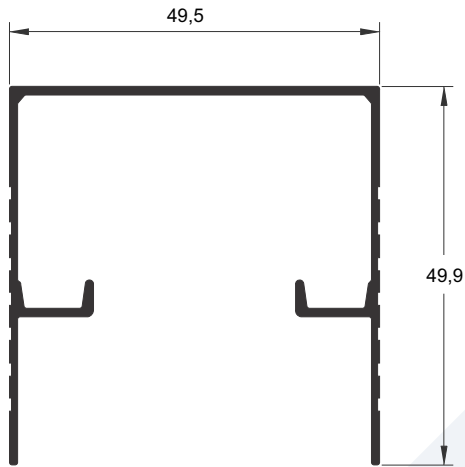

U-1243
0,534 kg/m

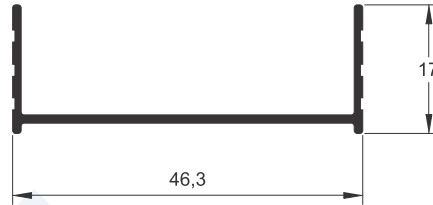

U-1245
0,183 kg/m

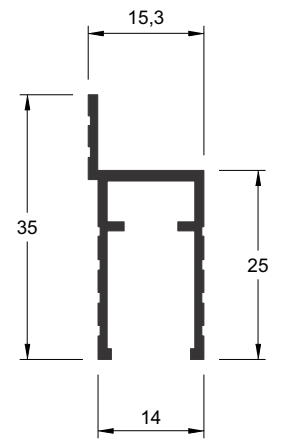

Y-310
0,243 kg/m

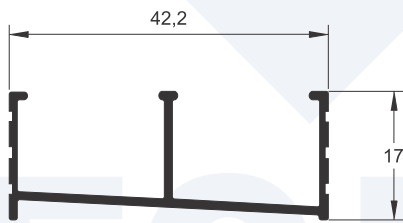

E-256
0,234 kg/m

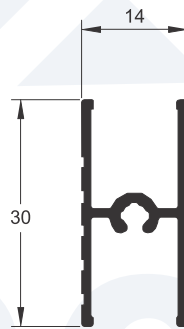

I-154
0,230 kg/m

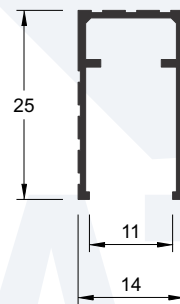

U-1002
0,180 kg/m

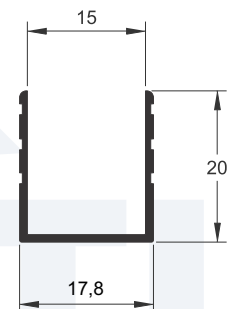

U-654
0,186 kg/m

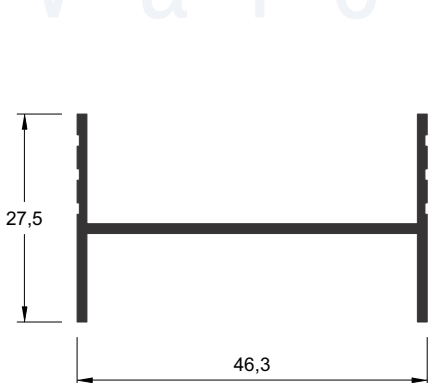

I-155
0,390 kg/m

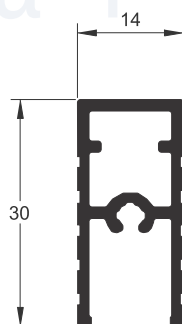

A-087
0,318 kg/m

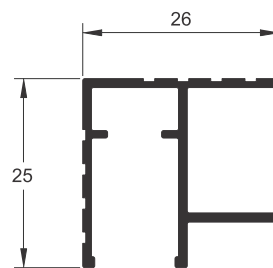

Y-308
0,302 kg/m

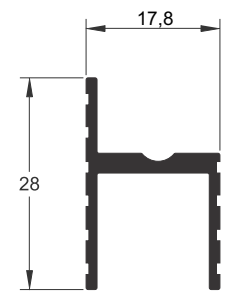

Y-311
0,232 kg/m

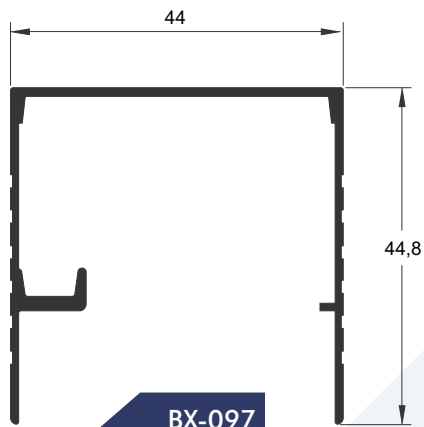

BX-097
0,495 kg/m

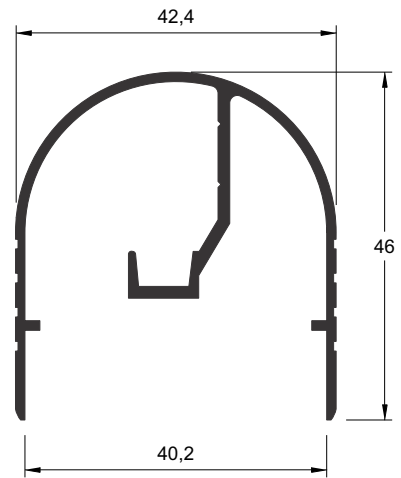

BX-140
0,504 kg/m

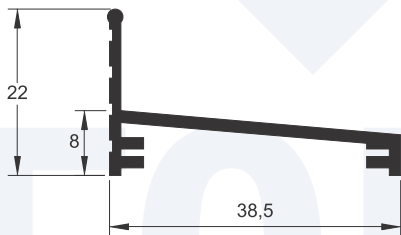

BX-089
0,251 kg/m

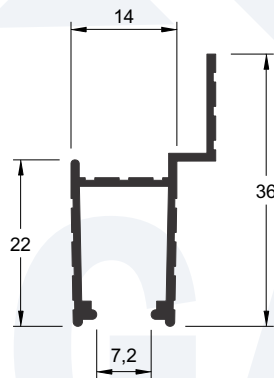

BX-088
0,203 kg/m

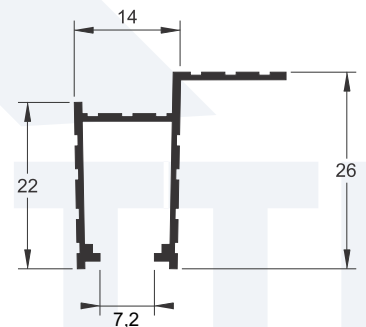

BX-091
0,200 kg/m

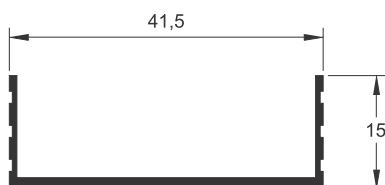

BX-085
0,181 kg/m

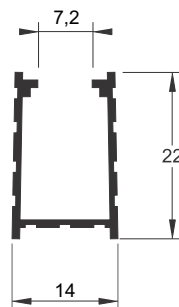

BX-087
0,154 kg/m

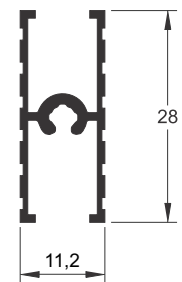

BX-090
0,208 kg/m

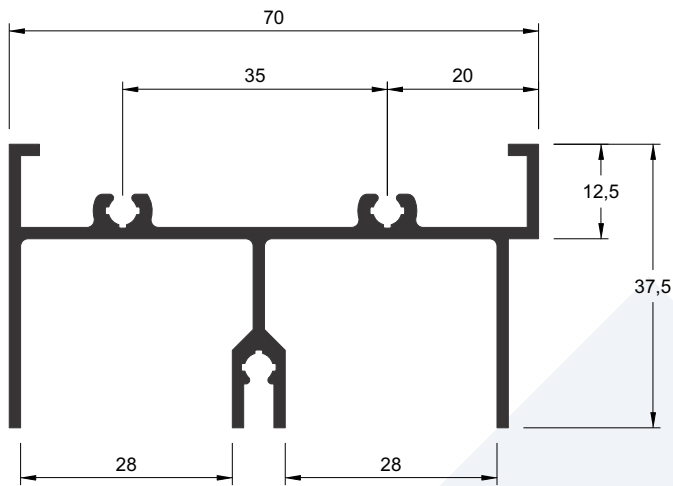

E-482
0,884 kg/m

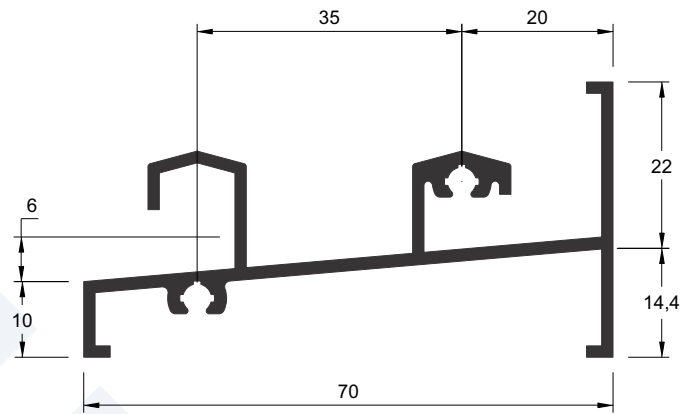

Z-176
0,854 kg/m

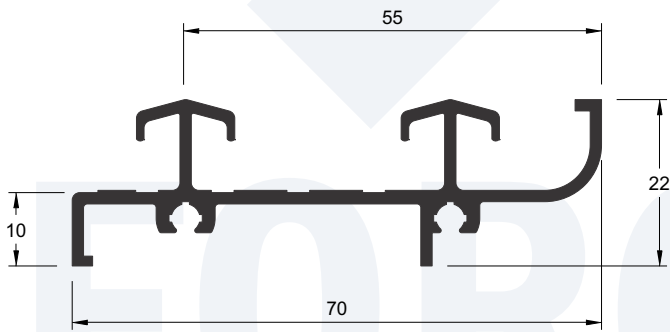

Z-267
0,729 kg/m

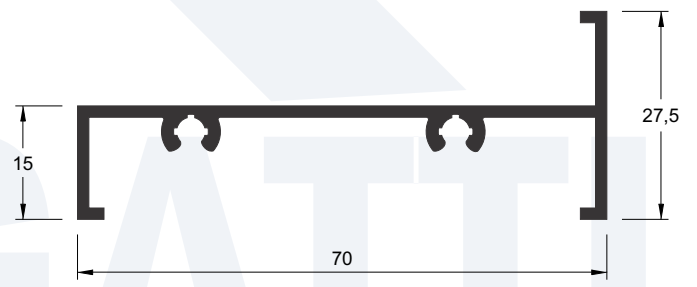

Z-175
0,569 kg/m

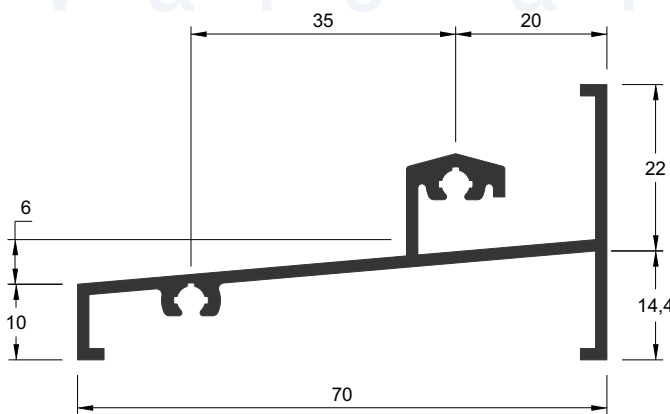

Z-174
0,726 kg/m

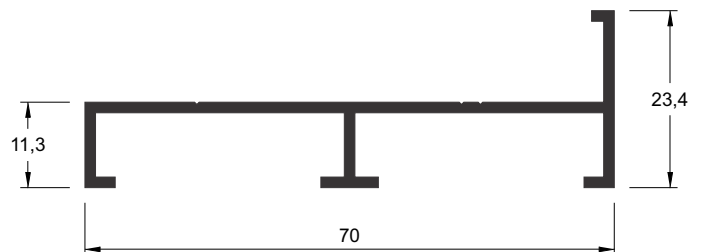

E-277
0,509 kg/m

Linha Convencional

Linha 25

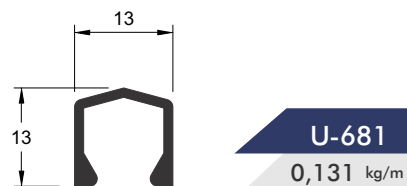
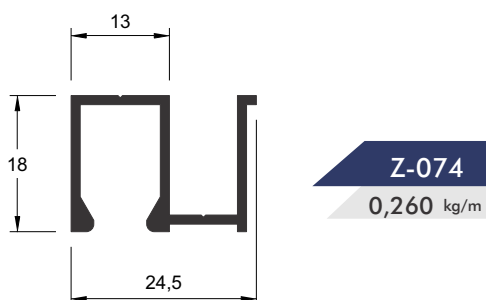
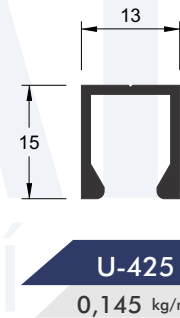
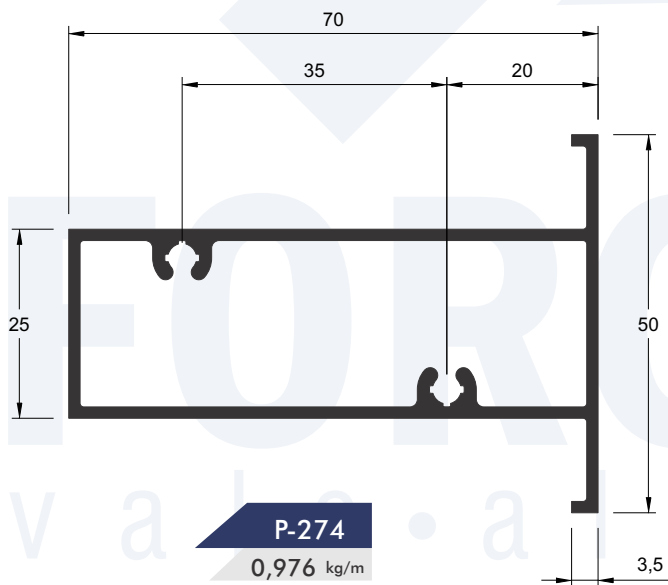
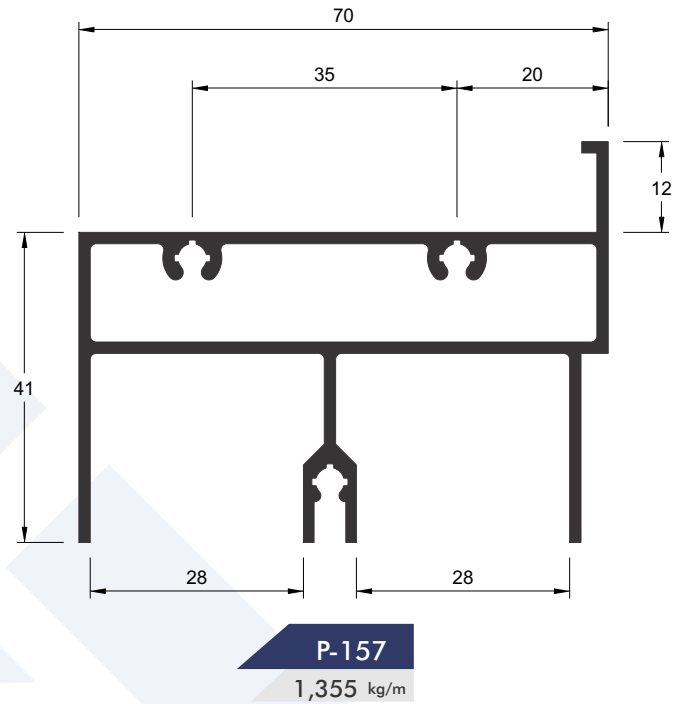
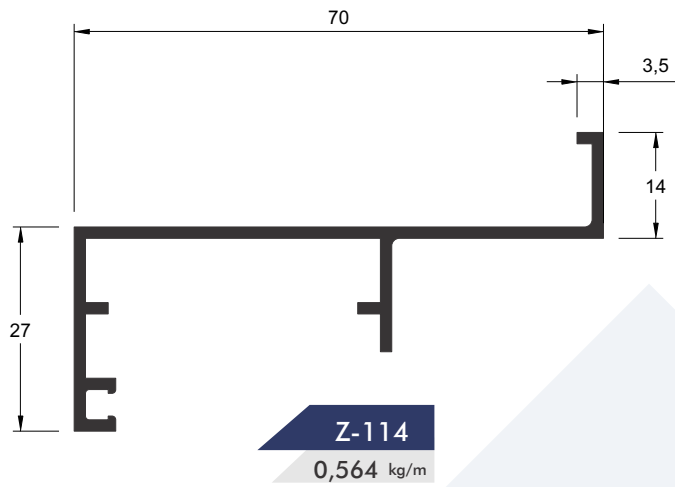

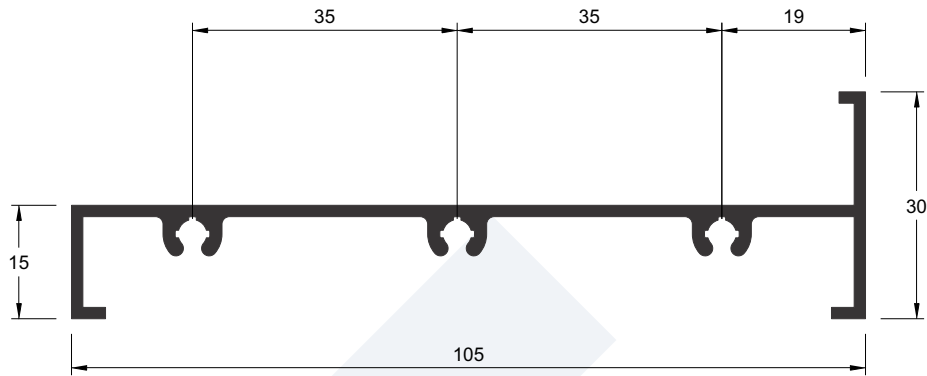

Y-260

0,816 kg/m

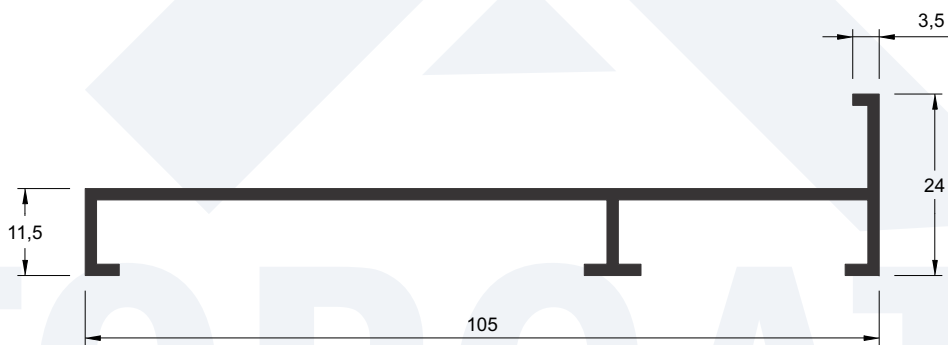

E-484

0,650 kg/m

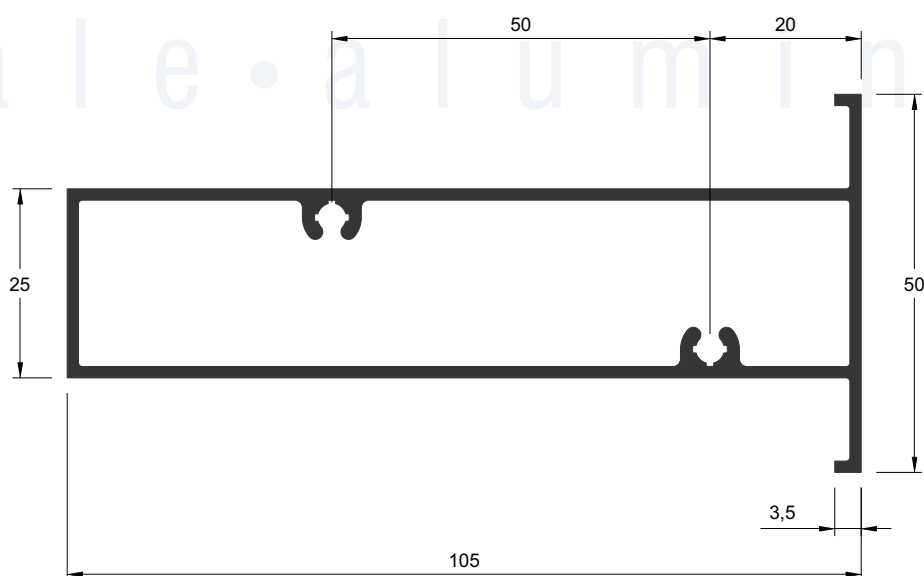

P-570

1,257 kg/m

Linha Convencional

Linha 25

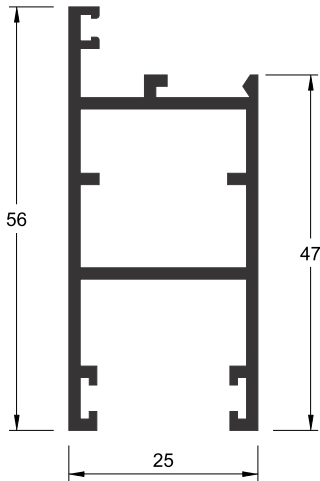

A-048
0,710 kg/m

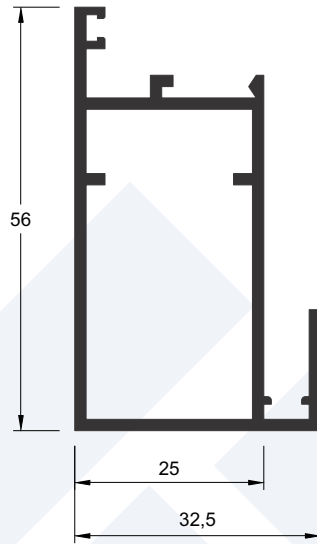

P-370
0,745 kg/m

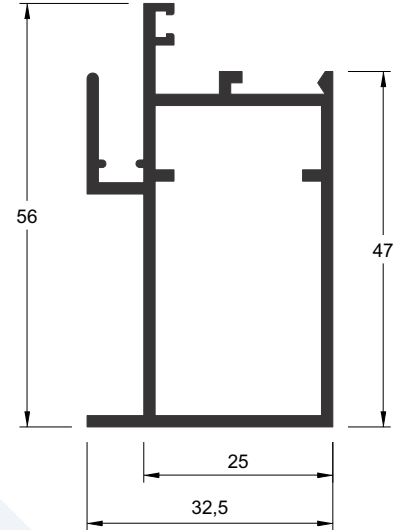

P-371
0,775 kg/m

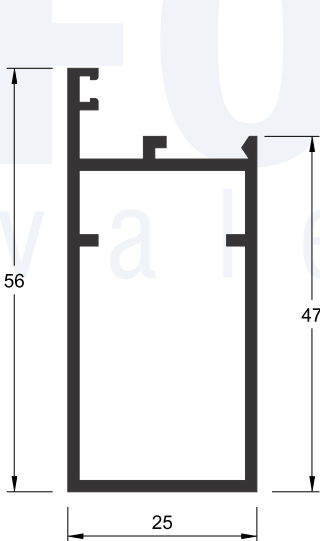

P-318
0,653 kg/m

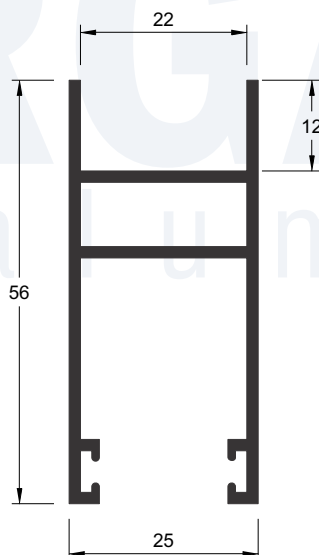

A-195
0,686 kg/m

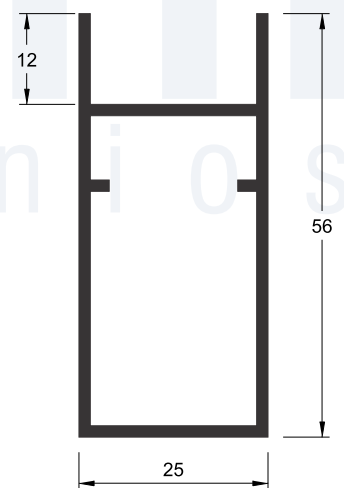

A-194
0,653 kg/m

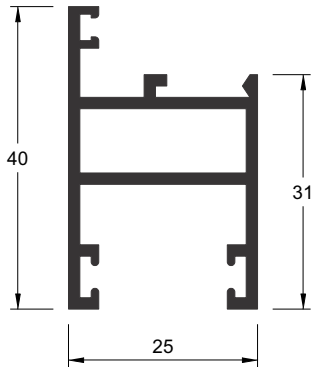

A-047

0,560 kg/m

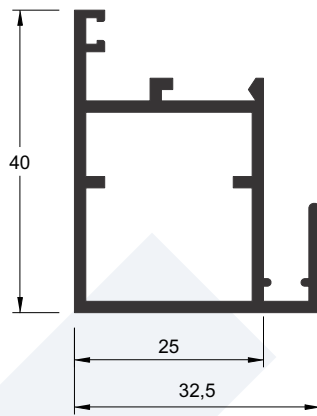

P-151

0,610 kg/m

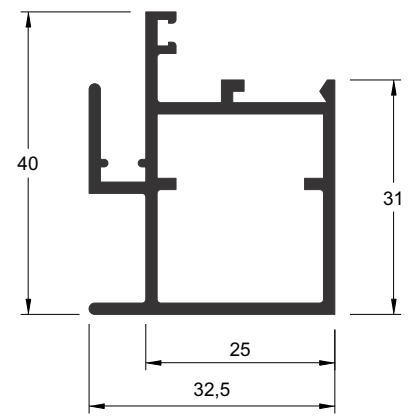

P-152

0,660 kg/m

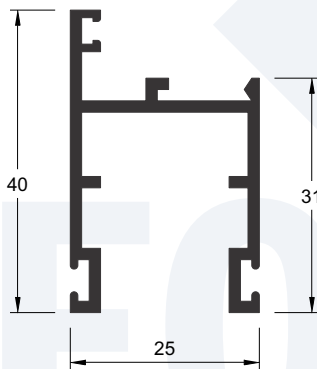

Y-196

0,485 kg/m

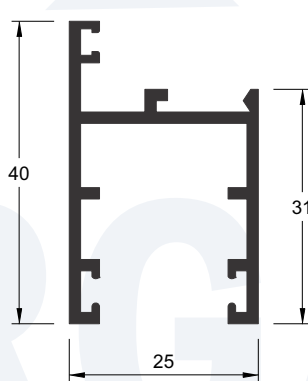

Y-195

0,480 kg/m

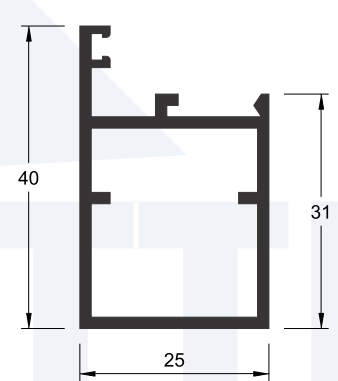

P-140

0,520 kg/m

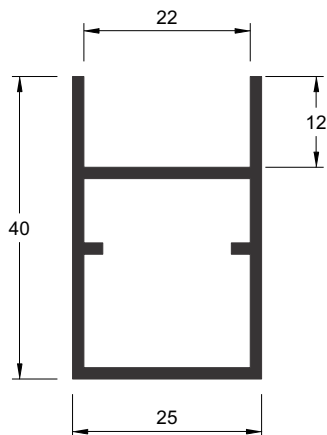

A-201

0,526 kg/m

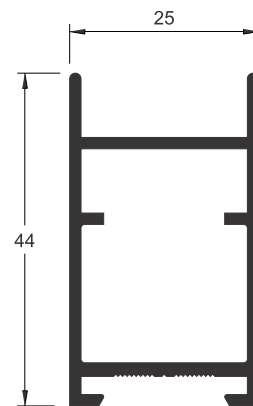

A-207

0,591 kg/m

Linha Convencional

Linha 25

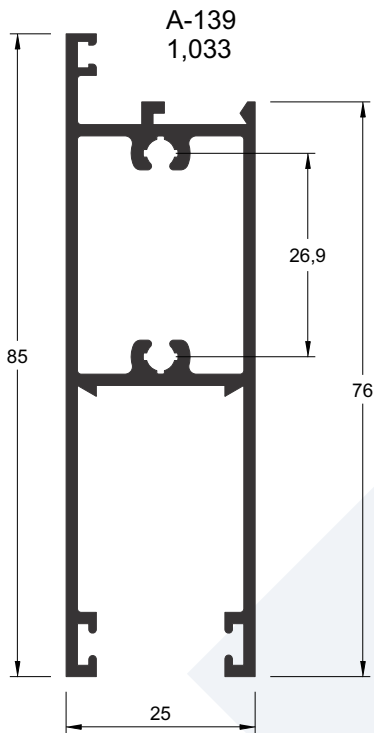

A-139
1,033 kg/m

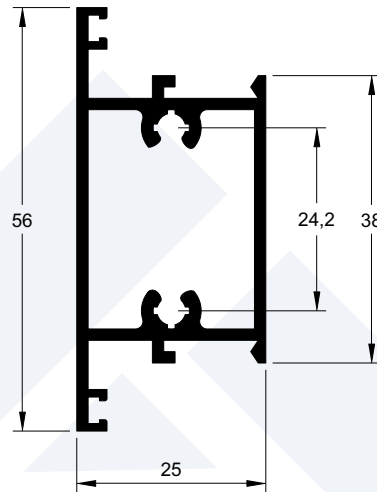

P-319
0,743 kg/m

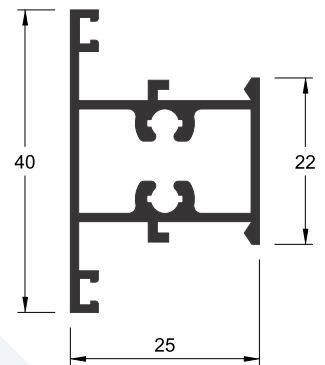

P-153
0,604 kg/m

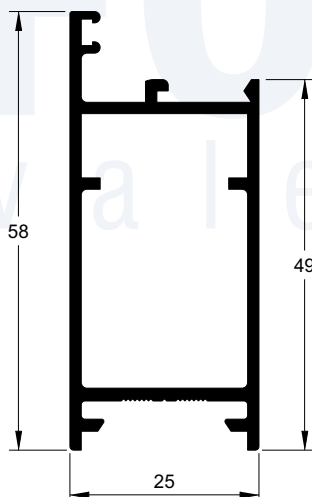

P-414
0,699 kg/m

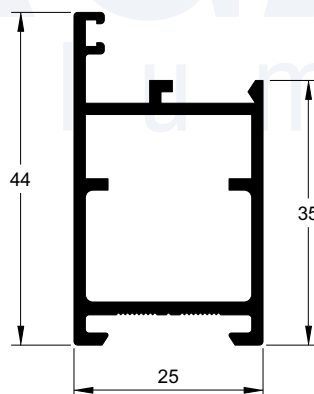

P-416
0,591 kg/m

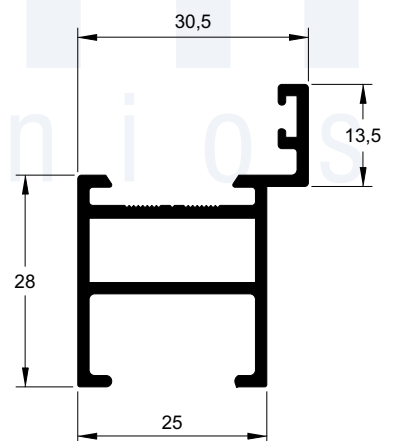

P-412
0,558 kg/m

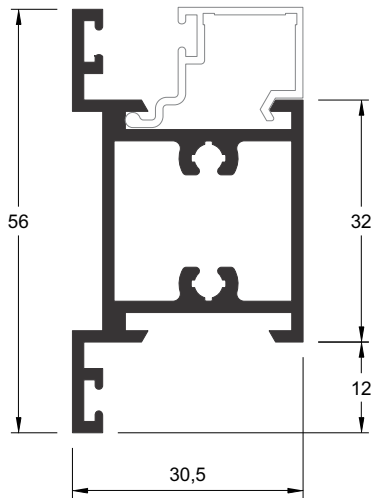

P-413
0,813 kg/m

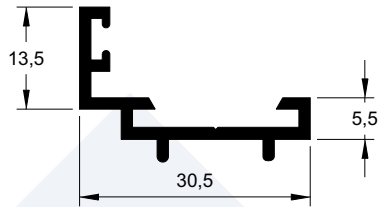

ES25-548
0,283 kg/m

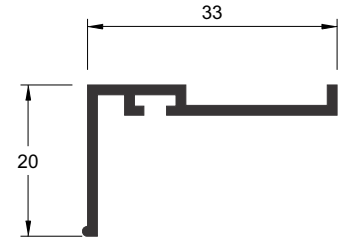

L-387
0,220 kg/m

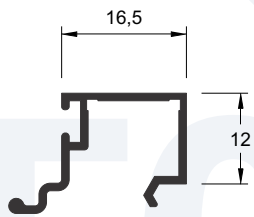

U-874
0,163 kg/m

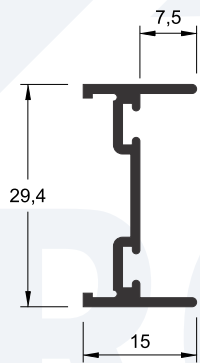

I-105
0,263 kg/m

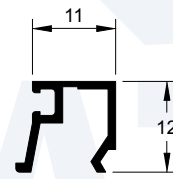

U-522
0,100 kg/m

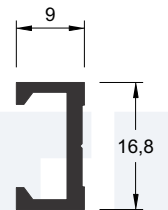

U-683
0,154 kg/m

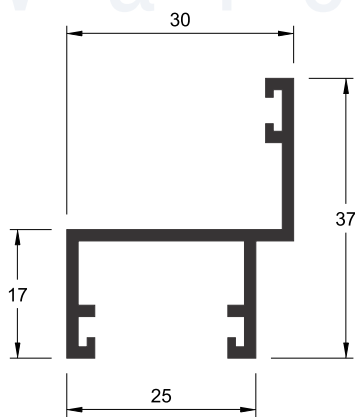

Y-126
0,260 kg/m

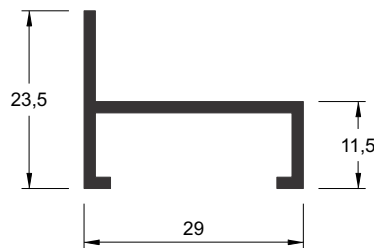

Y-120
0,260 kg/m

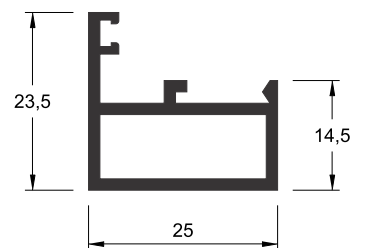

P-147
0,366 kg/m

Linha Convencional

Linha 25

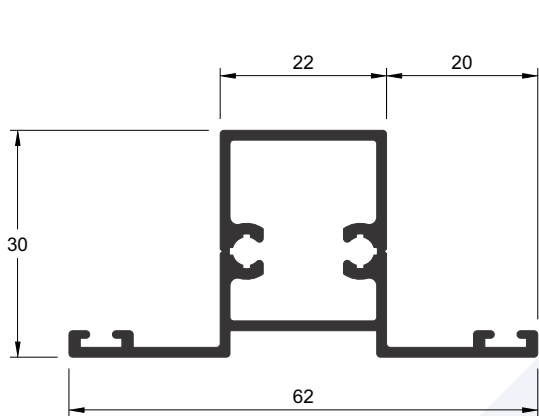

P-574
0,634 kg/m

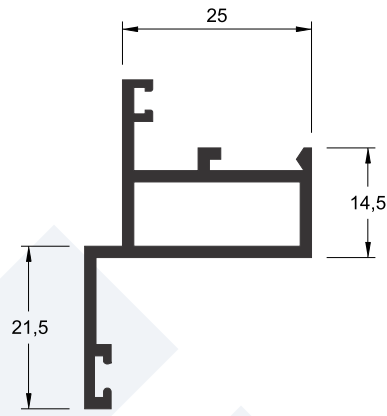

P-146
0,491 kg/m

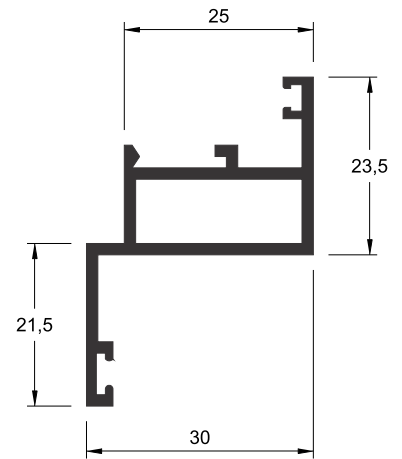

P-145
0,491 kg/m

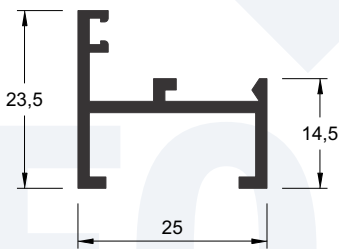

Y-197
0,298 kg/m

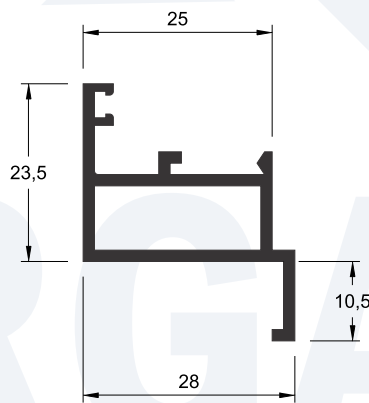

P-166
0,425 kg/m

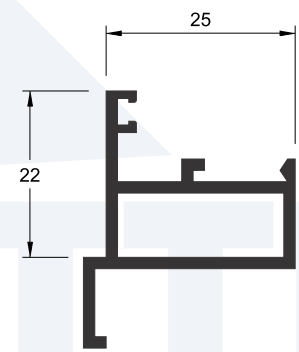

P-167
0,425 kg/m

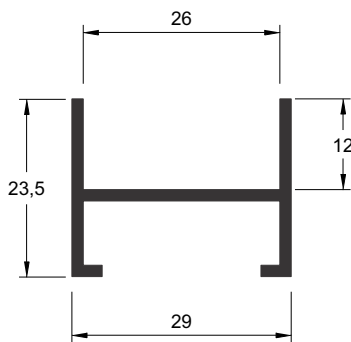

I-090
0,300 kg/m

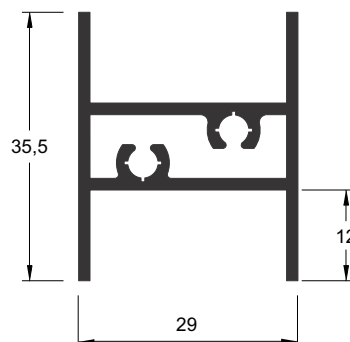

A-084
0,580 kg/m

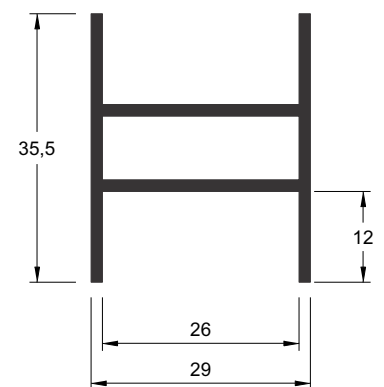

A-034
0,500 kg/m

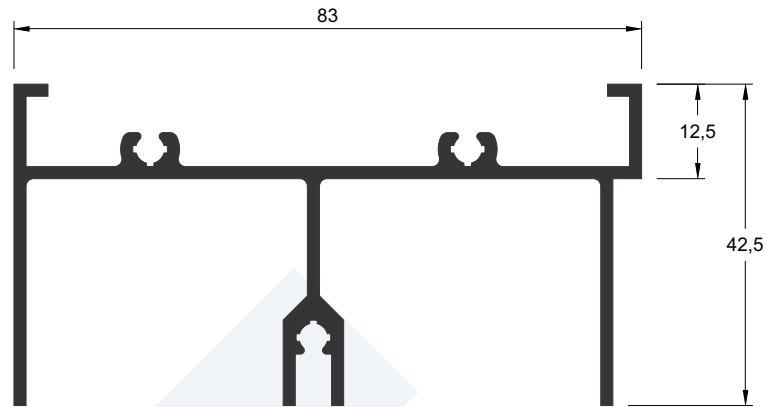

E-491

1,030 kg/m

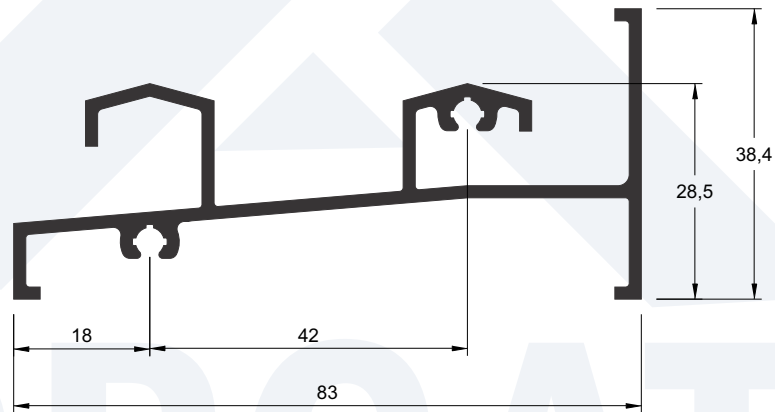

Z-183

0,989 kg/m

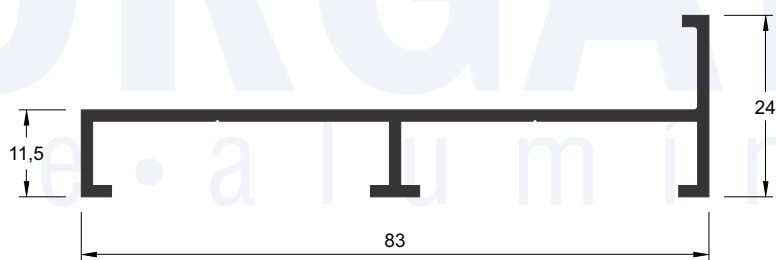

Z-181

0,564 kg/m

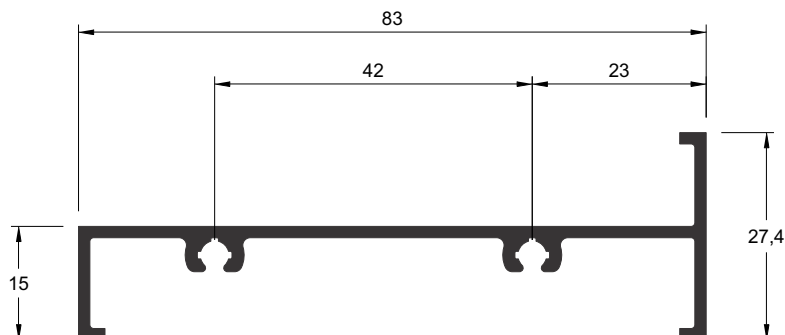

Z-182

0,662 kg/m

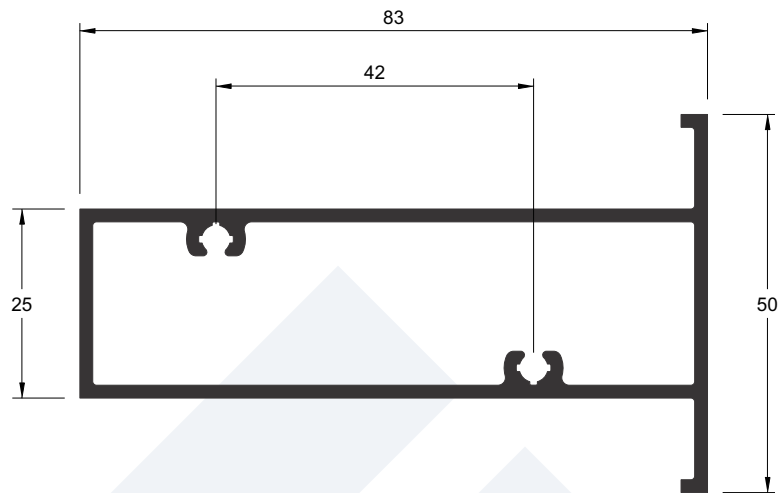

P-258

1,187 kg/m

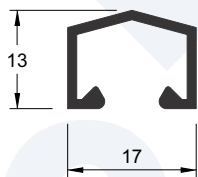

U-685

0,168 kg/m

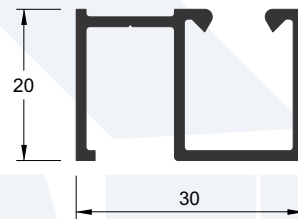

Z-082

0,340 kg/m

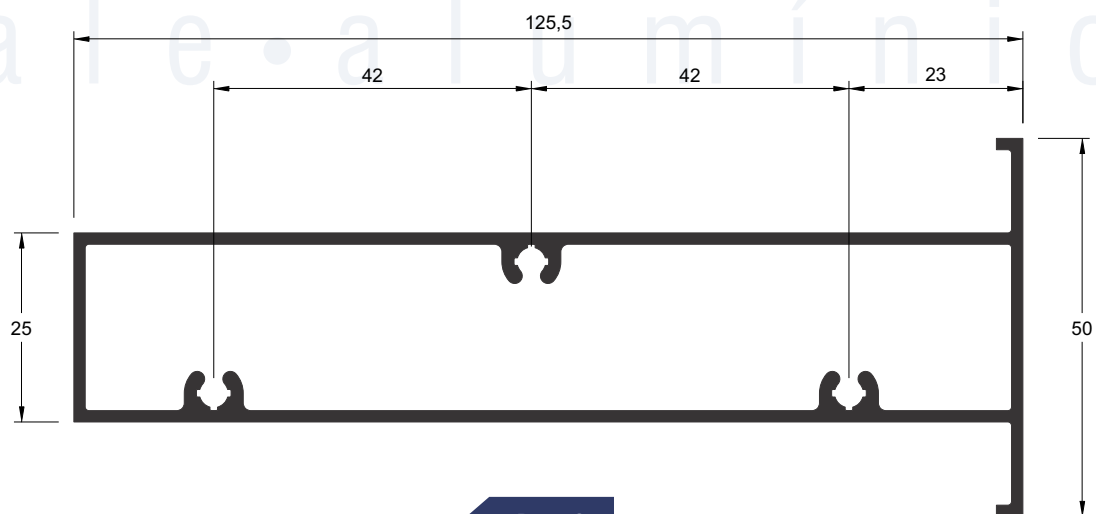

P-578

1,504 kg/m

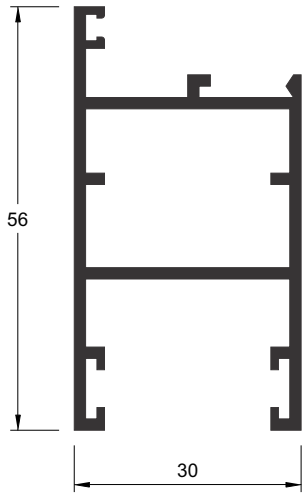

A-026

0,750 kg/m

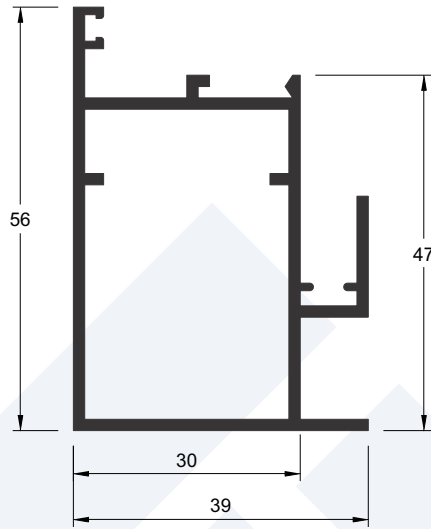

P-281

0,843 kg/m

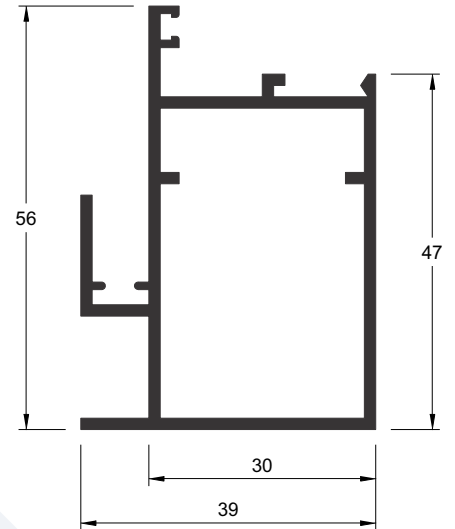

P-282

0,832 kg/m

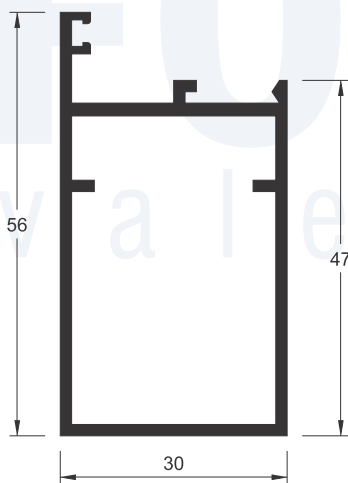

P-068

0,694 kg/m

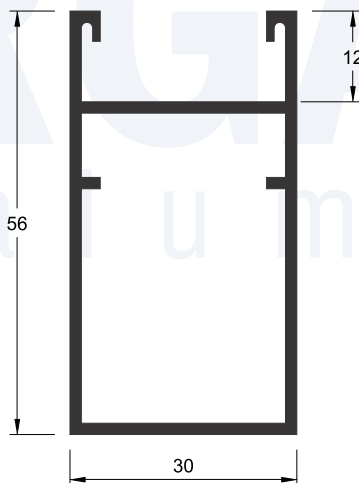

A-041

0,730 kg/m

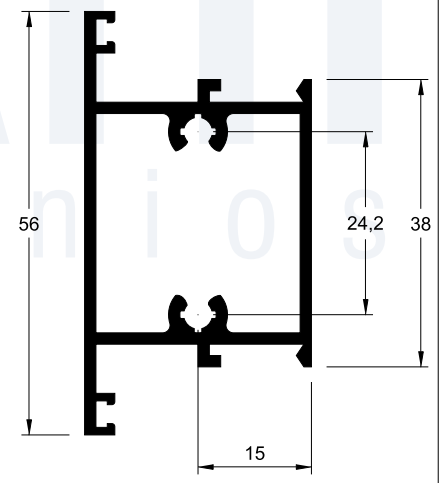

P-078

0,772 kg/m

Linha Convencional

Linha 30

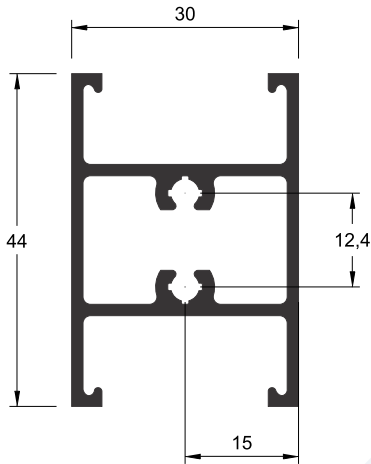

P-417

0,744 kg/m

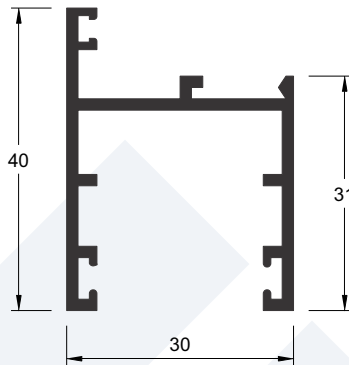

Y-131

0,506 kg/m

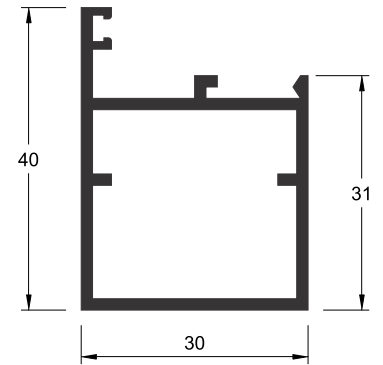

P-084

0,561 kg/m

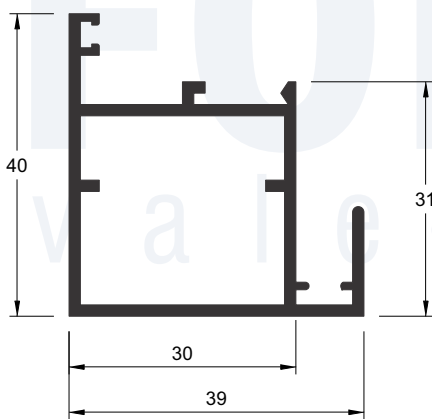

P-149

0,660 kg/m

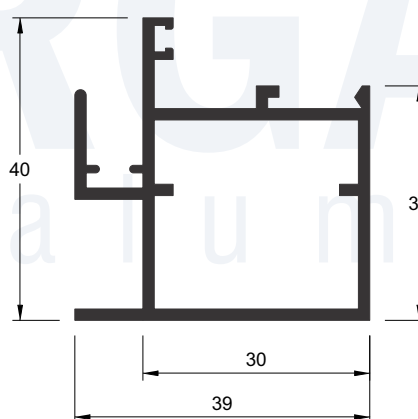

P-148

0,705 kg/m

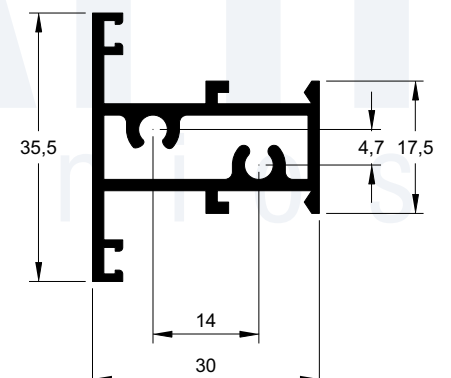

P-075

0,607 kg/m

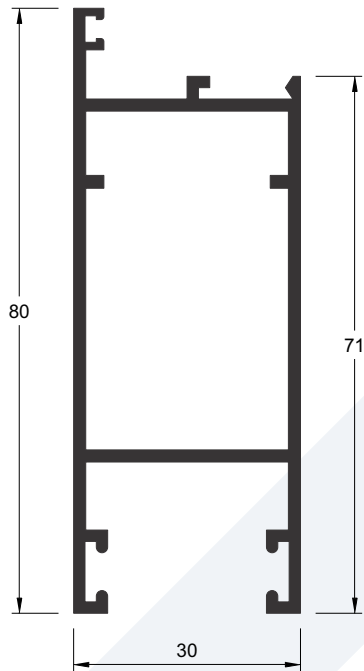

A-046
1,040 kg/m

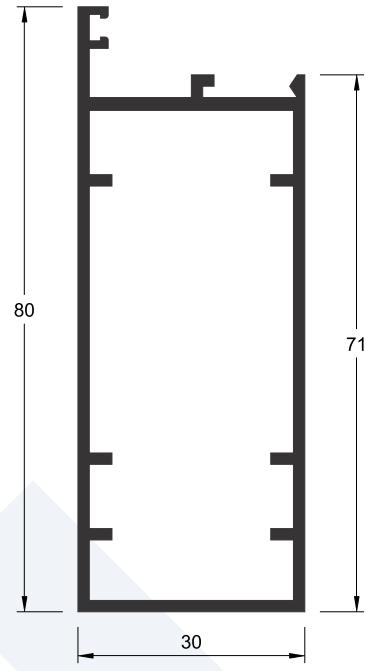

P-358
0,973 kg/m

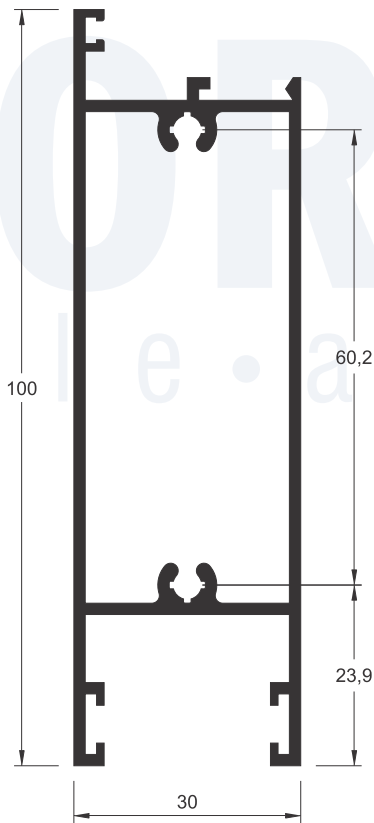

A-081
1,300 kg/m

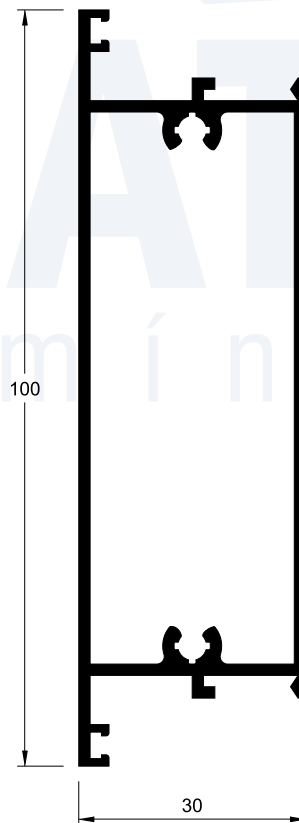

P-165
1,244 kg/m

Linha Convencional

Linha 30

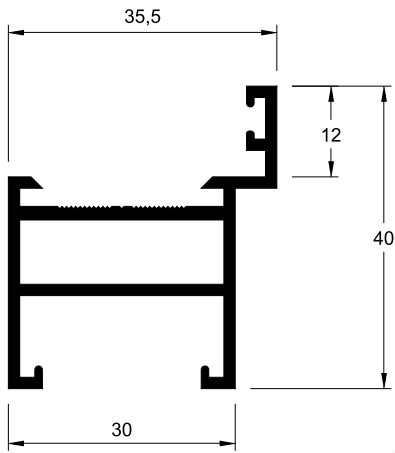

P-273

0,618 kg/m

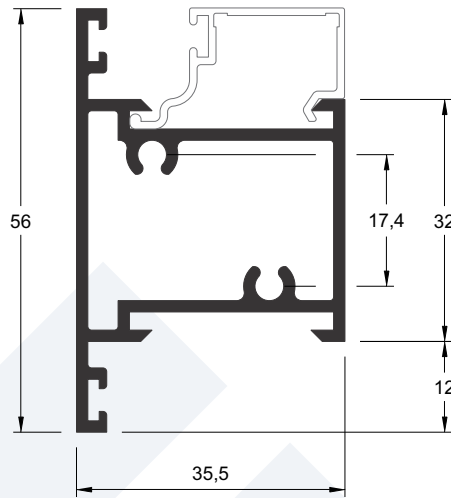

P-269

0,880 kg/m

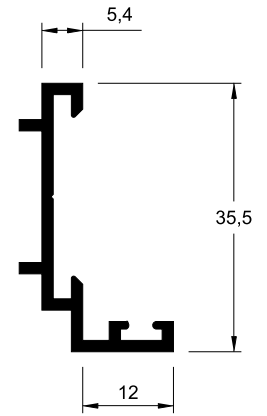

L-519

0,300 kg/m

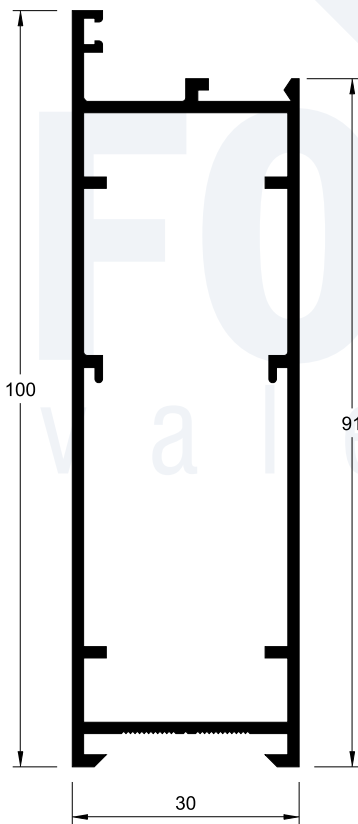

P-264

1,219 kg/m

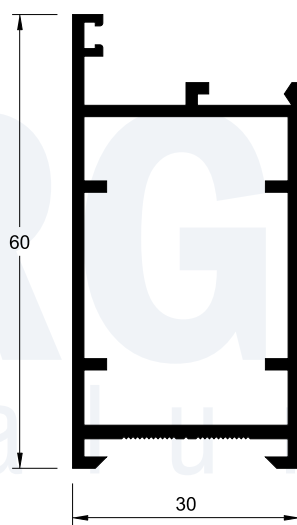

P-270

0,813 kg/m

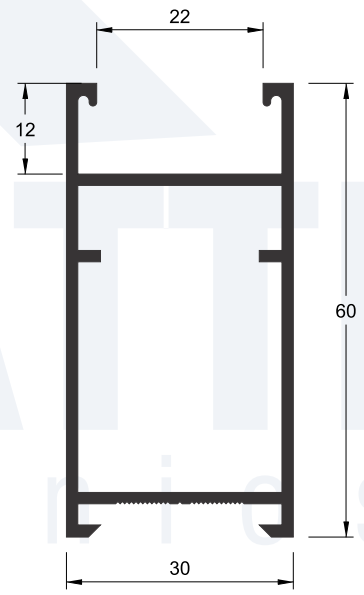

A-144

0,814 kg/m

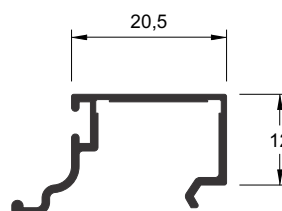

U-679

0,180 kg/m

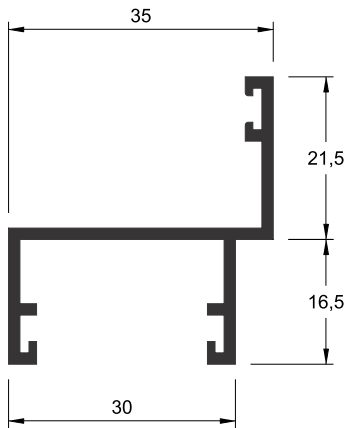

Y-140

0,428 kg/m

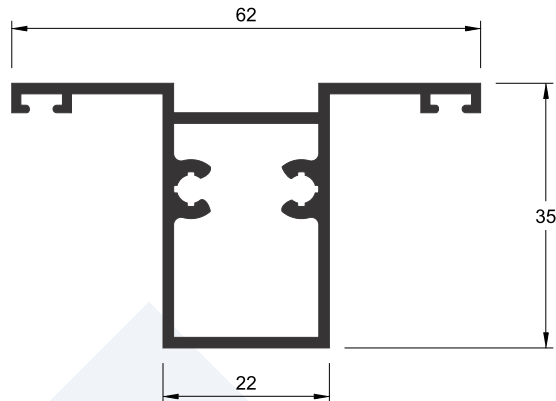

P-419

0,726 kg/m

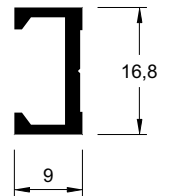

U-683

0,154 kg/m

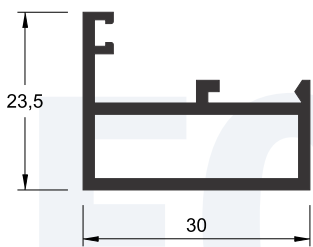

P-064

0,400 kg/m

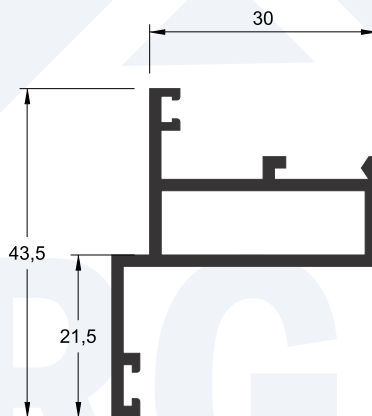

P-120

0,535 kg/m

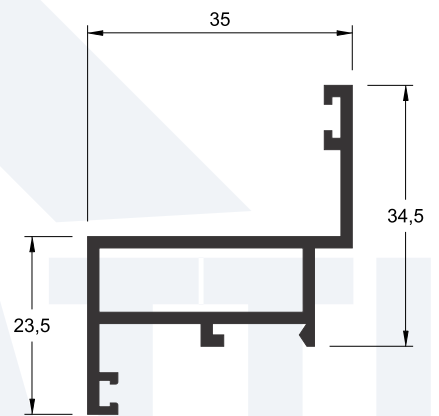

P-121

0,535 kg/m

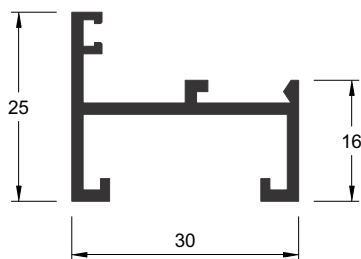

Y-113

0,345 kg/m

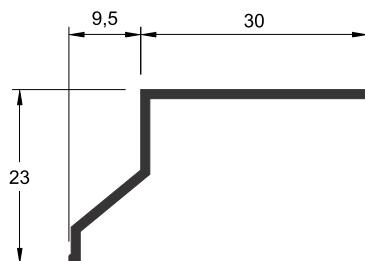

L-332

0,210 kg/m

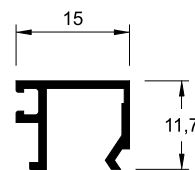

U-482

0,115 kg/m

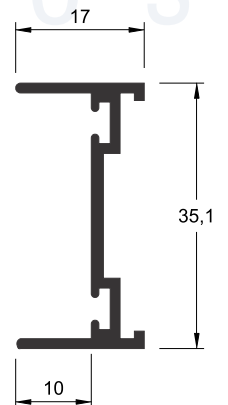

E-150

0,285 kg/m

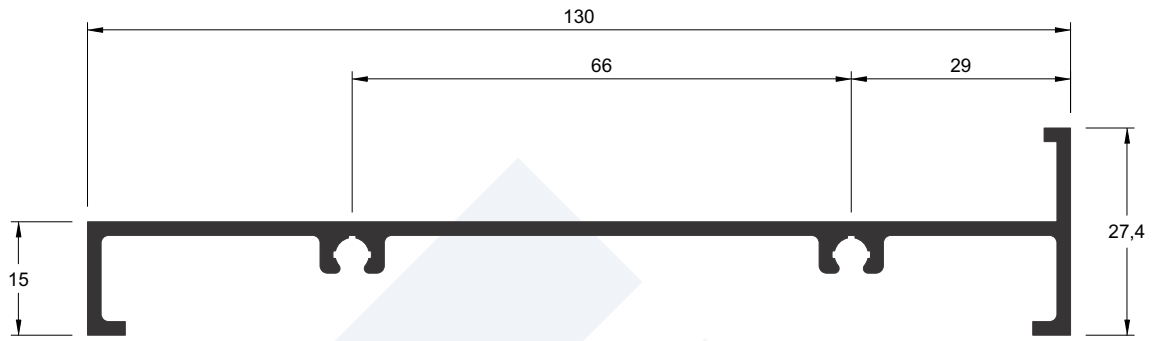

Y-350
0,984 kg/m

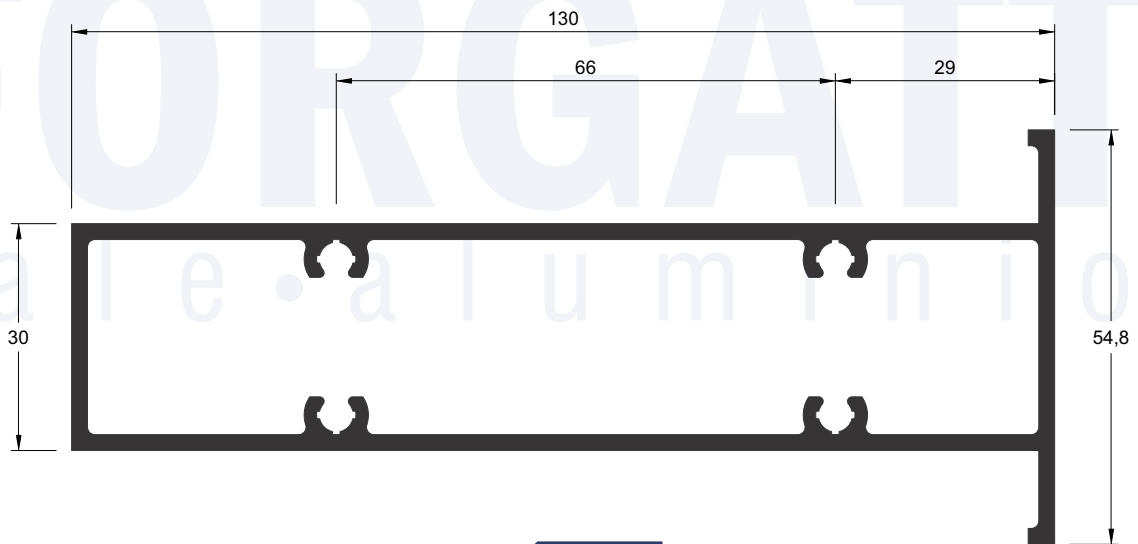

P-278
2,201 kg/m

Linha Convencional

Linha 42

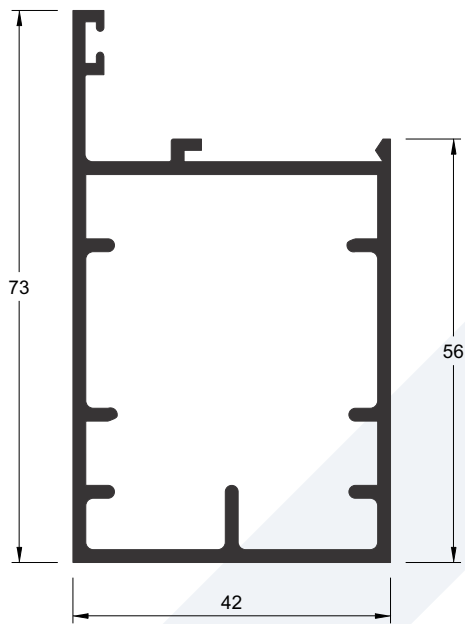

P-4261

1,137 kg/m

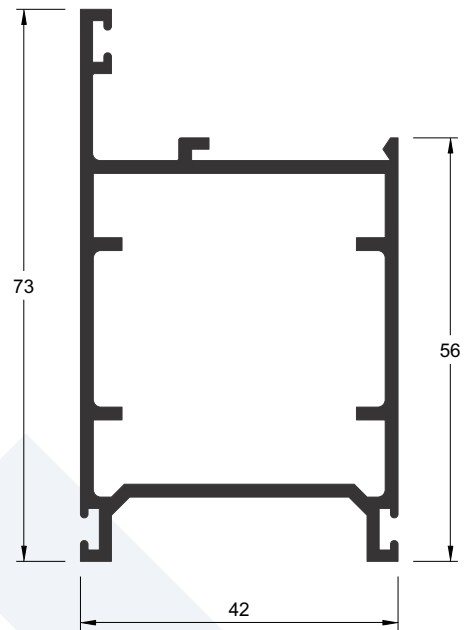

P-267

1,016 kg/m

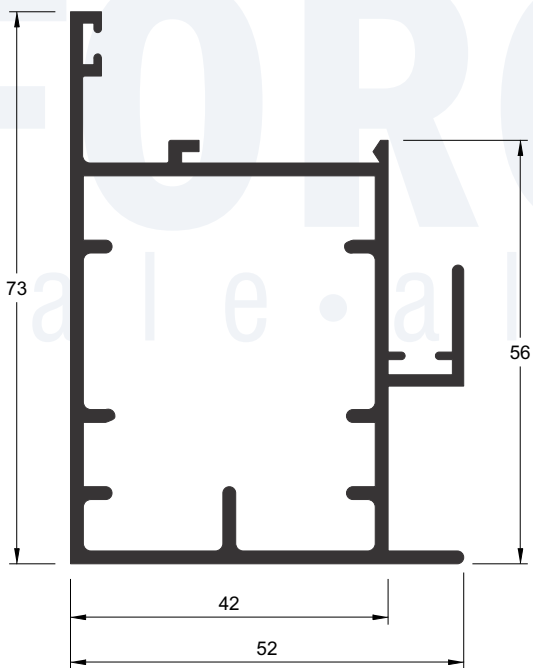

P-4263

1,292 kg/m

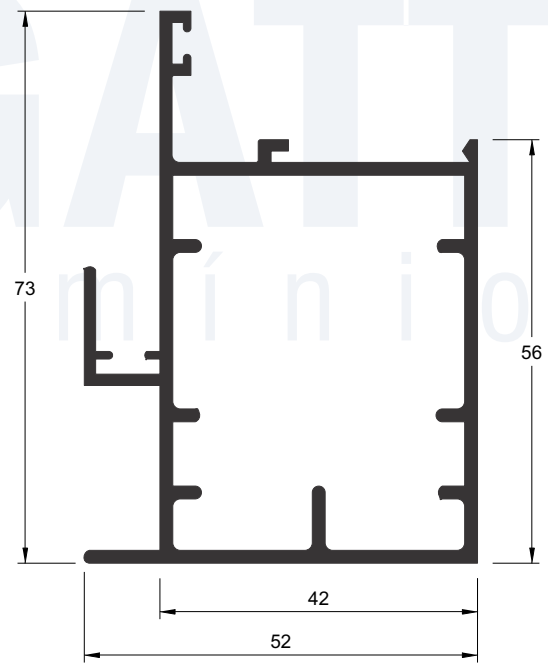

P-4262

1,211 kg/m

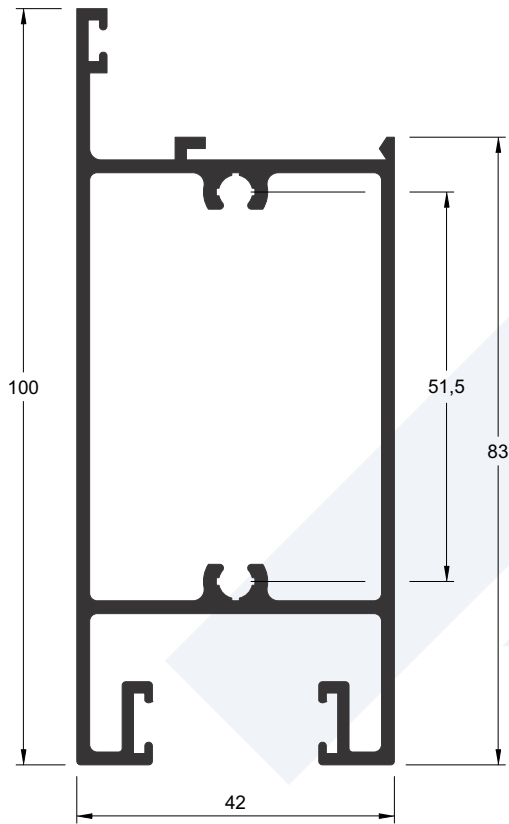

A-103
1,545 kg/m

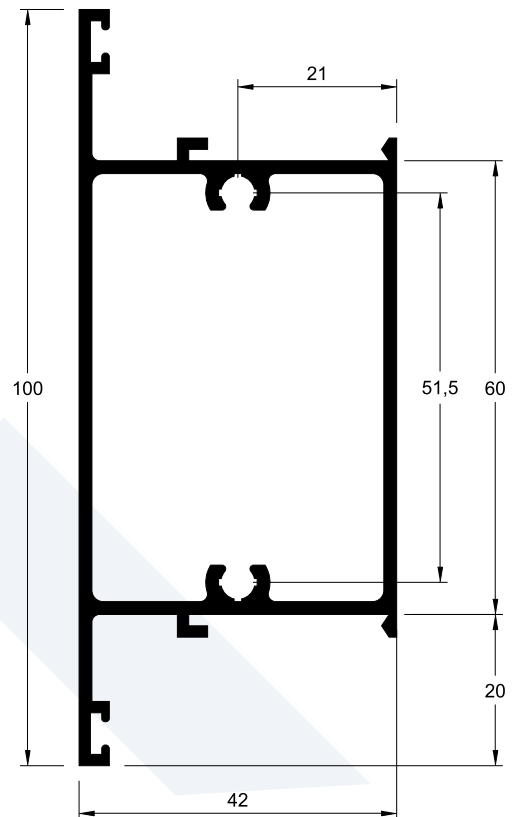

P-279
1,275 kg/m

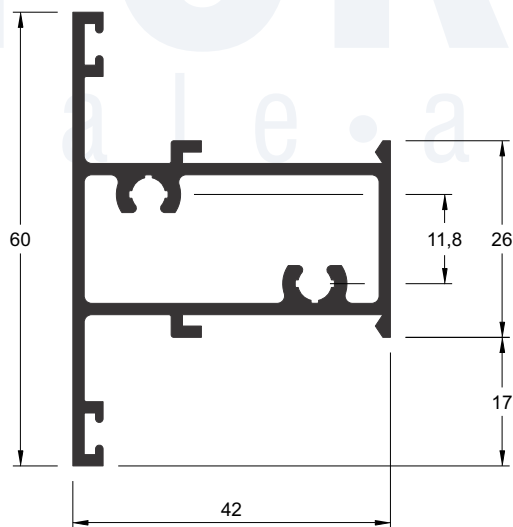

P-194
0,862 kg/m

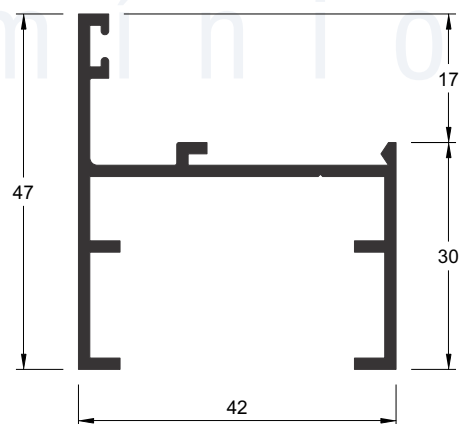

Y-271
0,610 kg/m

Linha Convencional

Linha 42

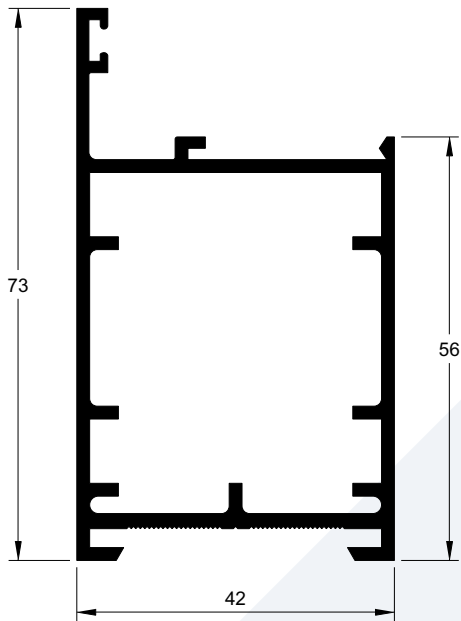

P-250A

1,172 kg/m

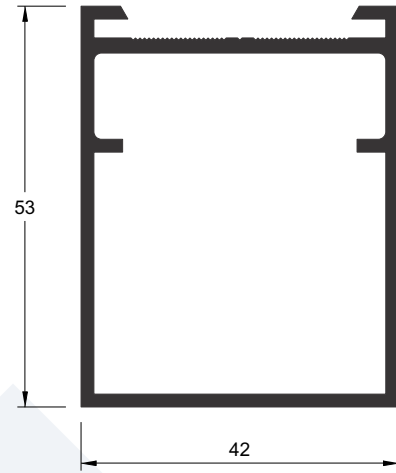

A-104

0,870 kg/m

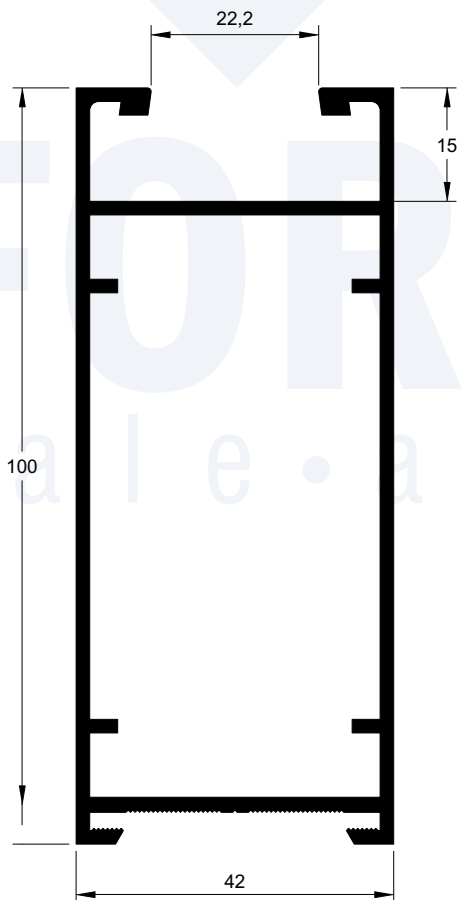

A-1730

1,510 kg/m

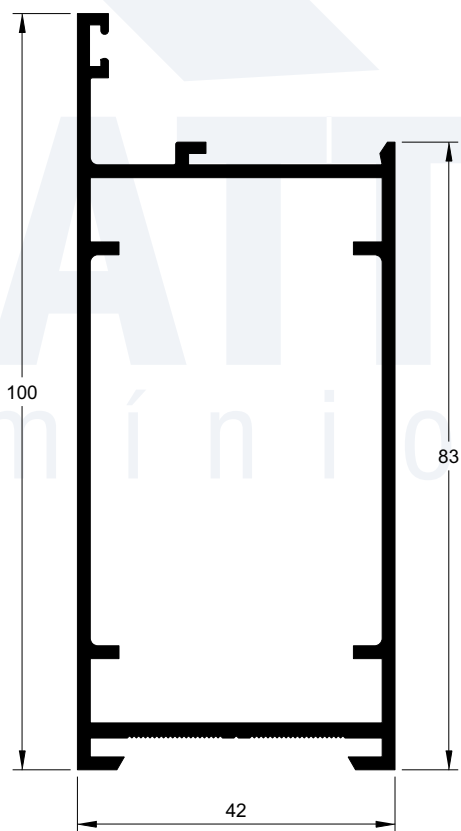

P-268A

1,373 kg/m

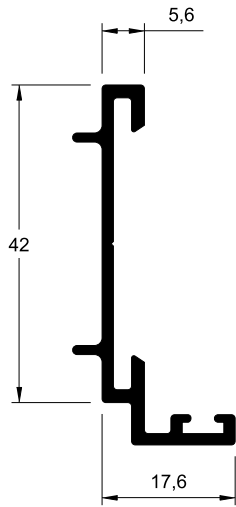

L-521

0,362 kg/m

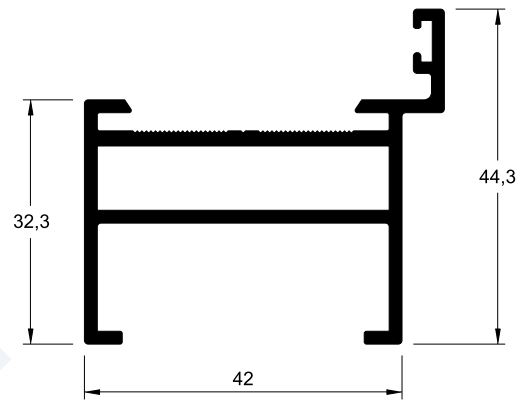

P-280

0,870 kg/m

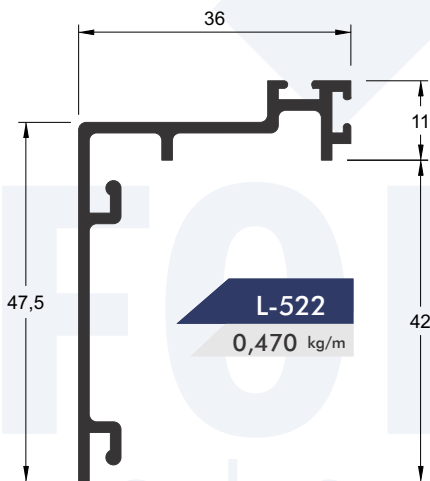

L-522

0,470 kg/m

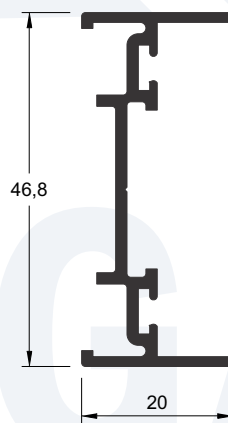

I-173

0,434 kg/m

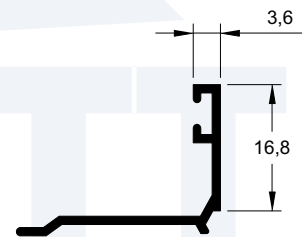

L-473

0,192 kg/m

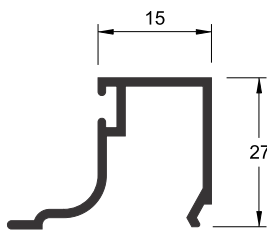

U-696

0,220 kg/m

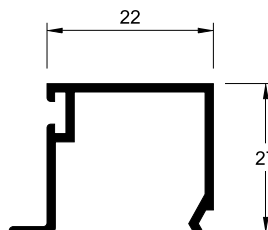

U-1076

0,200 kg/m

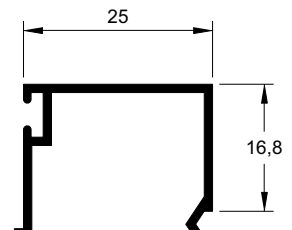

U-611

0,225 kg/m

Linha Convencional

Linha 42

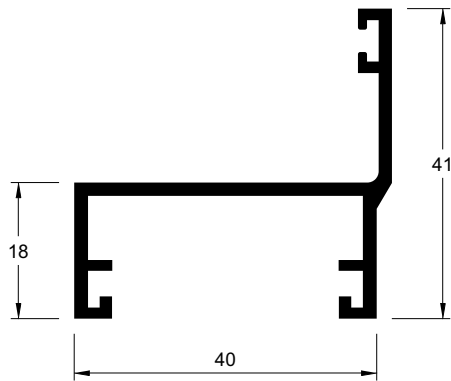

Y-181
0,580 kg/m

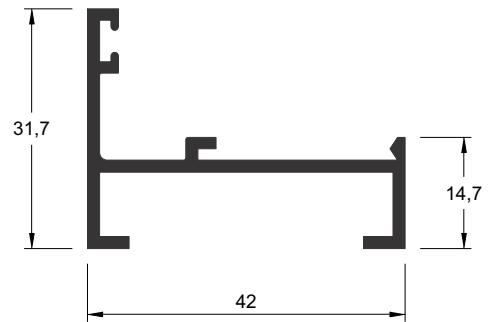

Y-351
0,440 kg/m

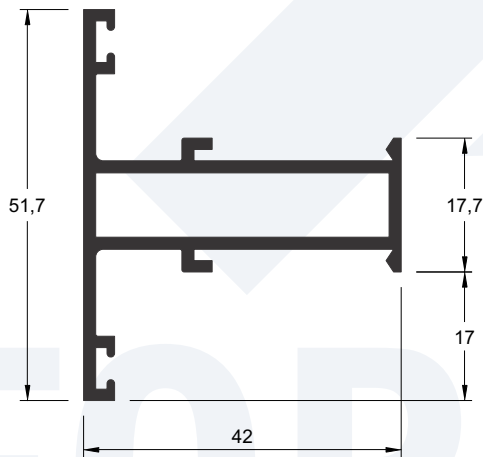

P-192
0,730 kg/m

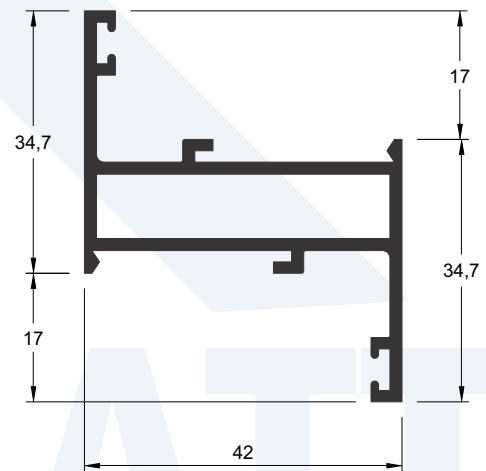

P-193
0,740 kg/m

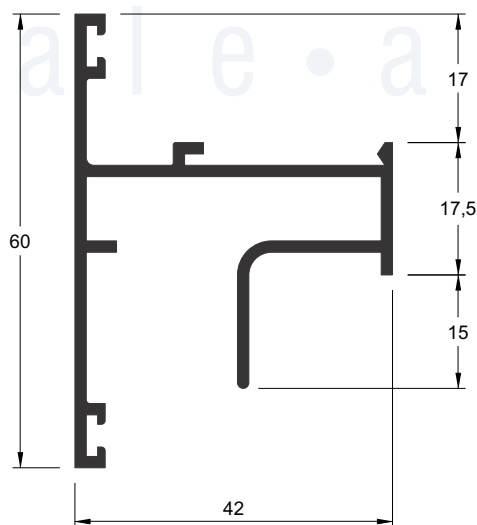

Y-273
0,705 kg/m

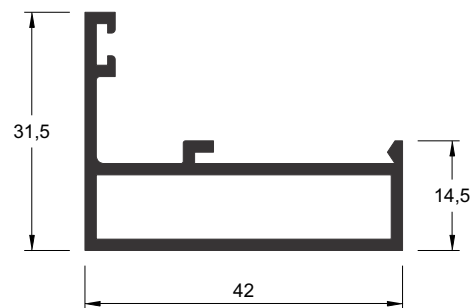

P-253
0,595 kg/m

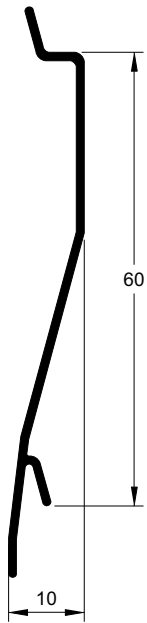

Z-201
0,250 kg/m

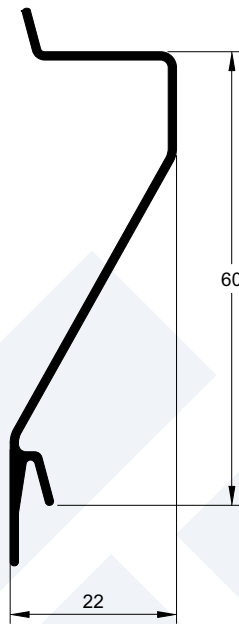

Z-203
0,325 kg/m

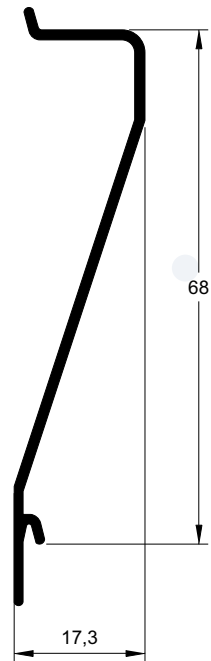

VA-017
0,266 kg/m

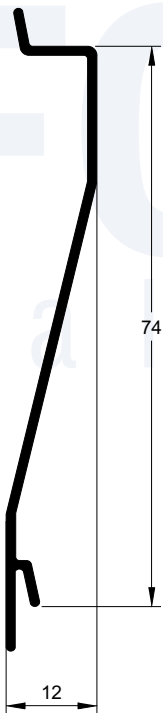

VA-012
0,276 kg/m

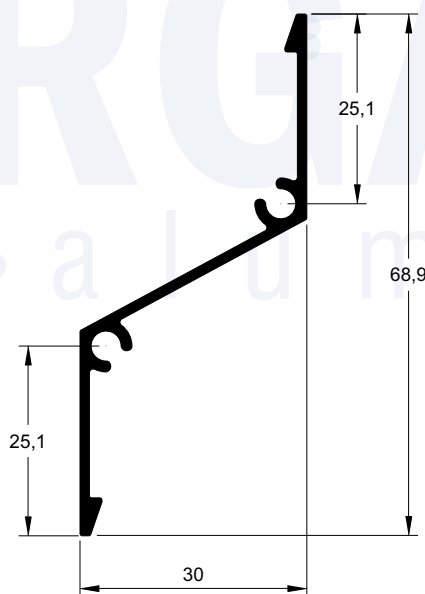

VZ-060
0,397 kg/m

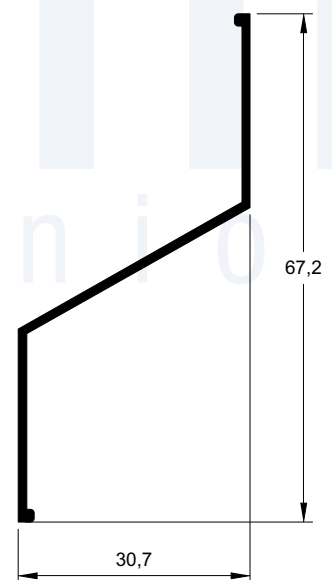

VZ-063
0,263 kg/m

Linha Convencional

Venezas e Brises

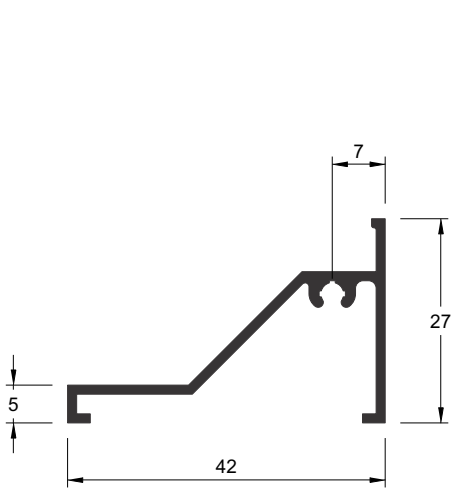

Y-689

0,301 kg/m

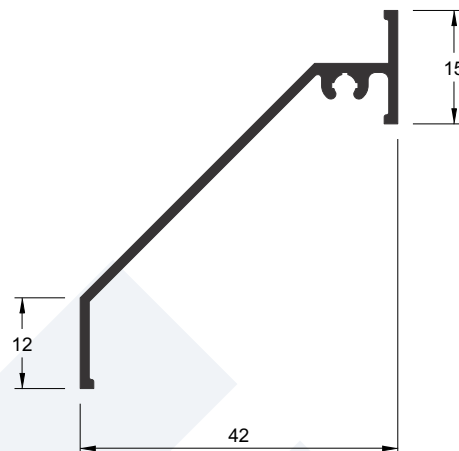

Z-248

0,298 kg/m

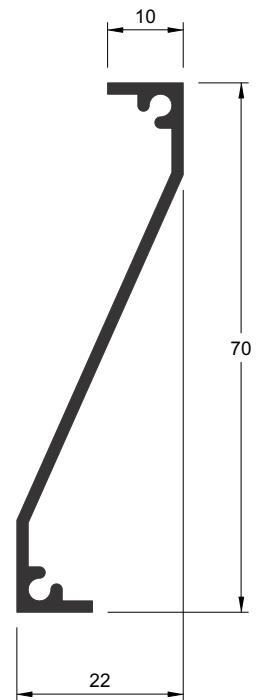

Z-194

0,348 kg/m

D-059

0,845 kg/m

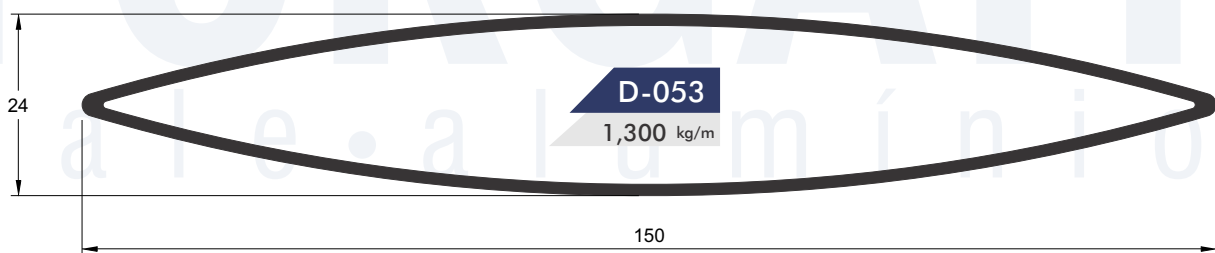
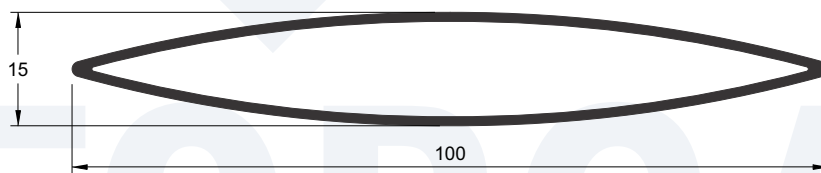

D-053

1,300 kg/m

D-054

0,970 kg/m

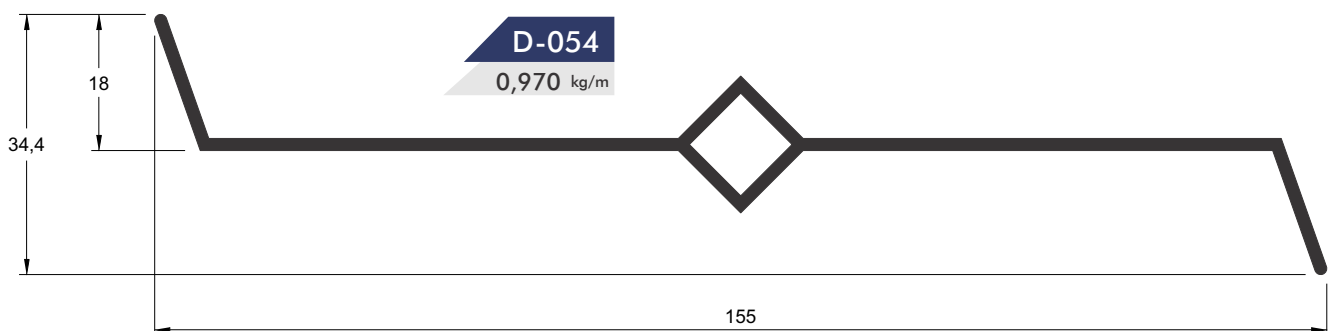

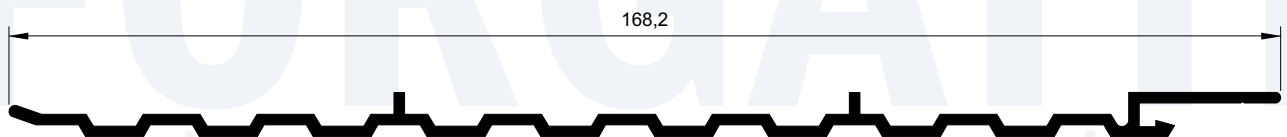
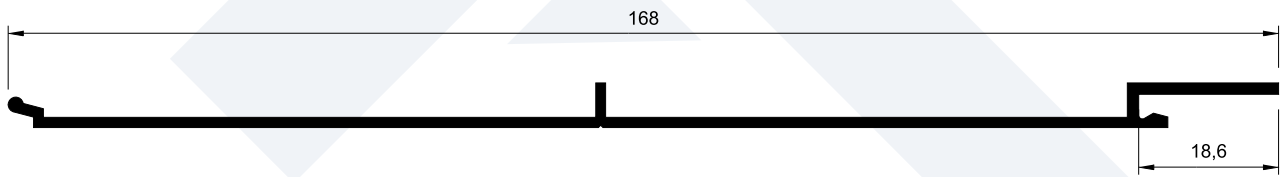
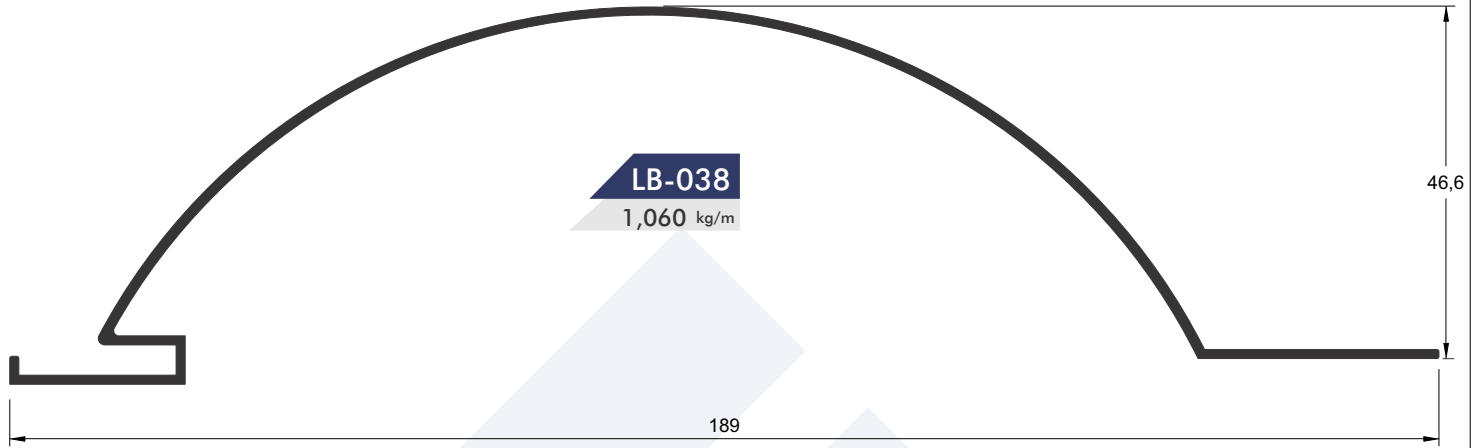

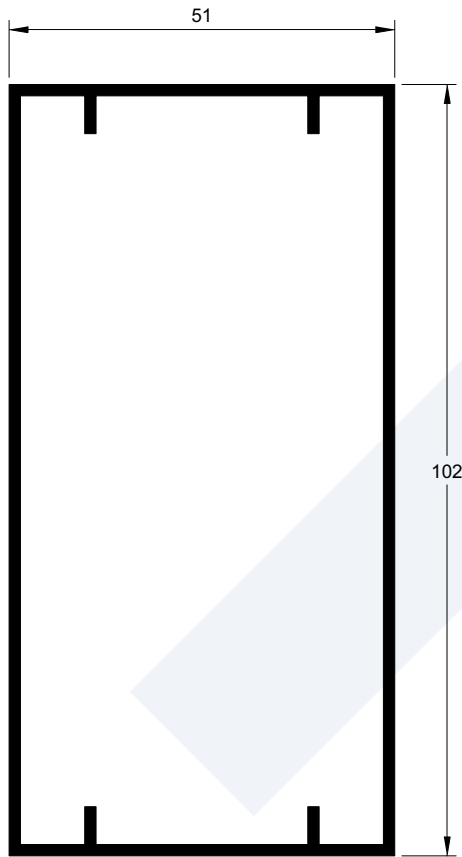

D-042

1,555 kg/m

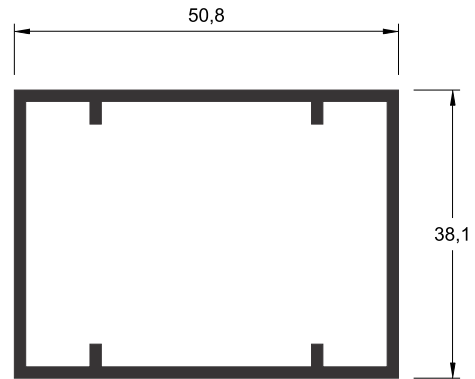

D-078

0,794 kg/m

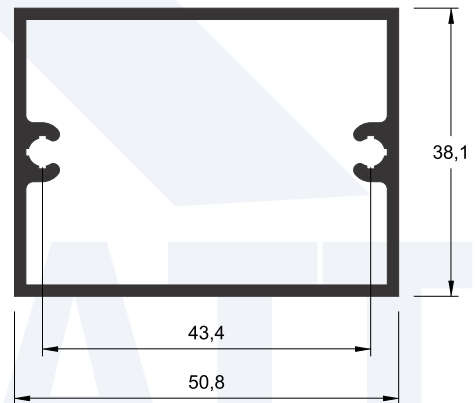

D-103

0,800 kg/m

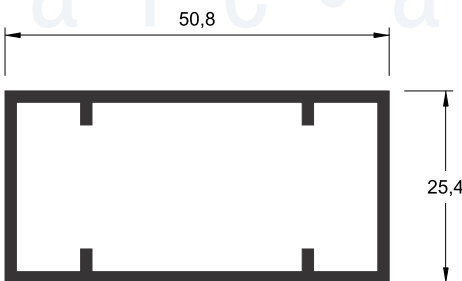

D-079

0,645 kg/m

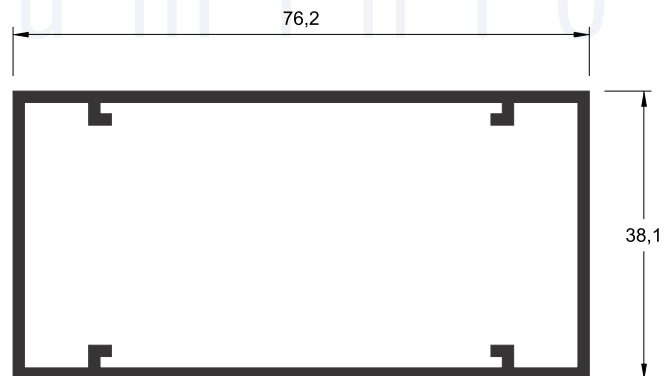

D-069

1,110 kg/m

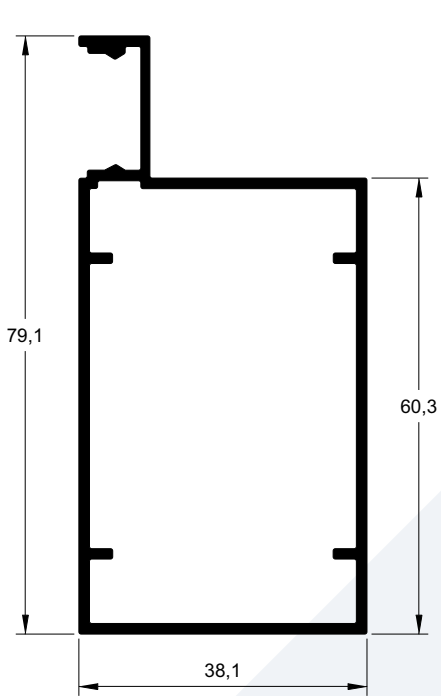

D-778

0,897 kg/m

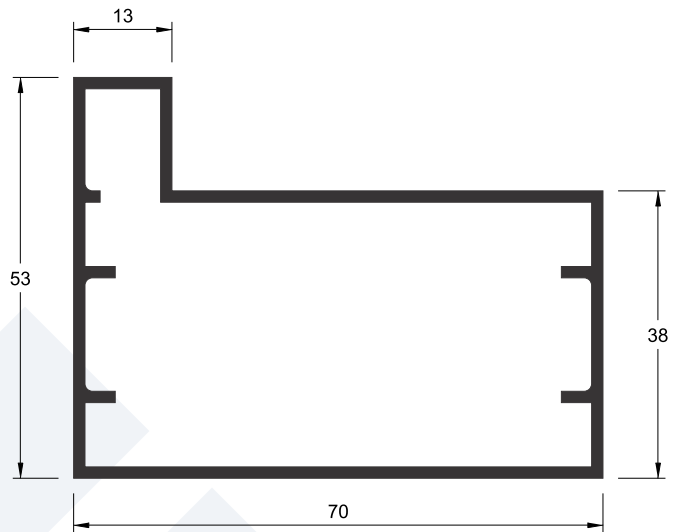

PC-010

1,585 kg/m

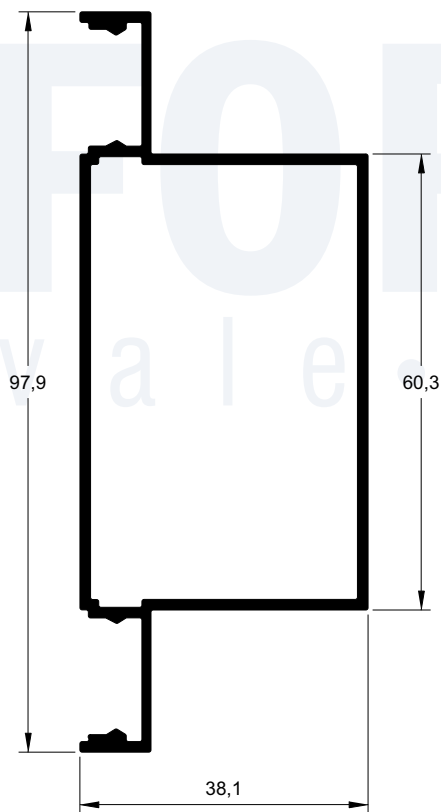

D-777

0,974 kg/m

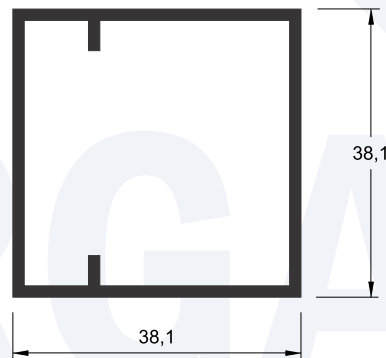

D-102

0,629 kg/m

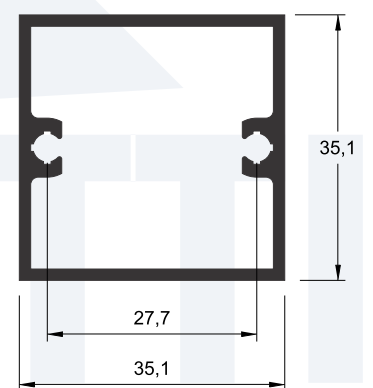

D-081

0,667 kg/m

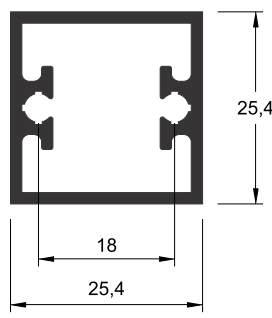

D-080

0,534 kg/m

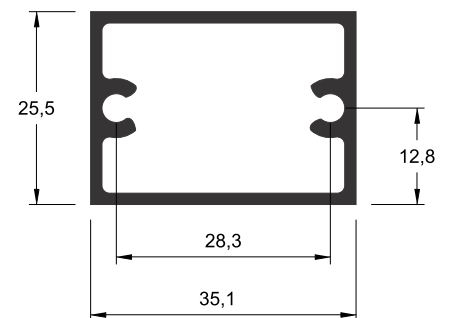

D-055

0,580 kg/m

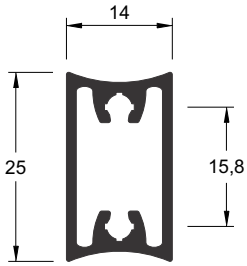

D-056
0,325 kg/m

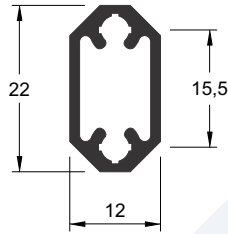

D-070
0,263 kg/m

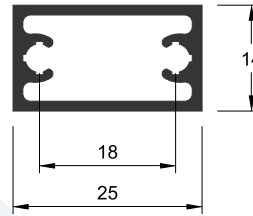

D-082
0,356 kg/m

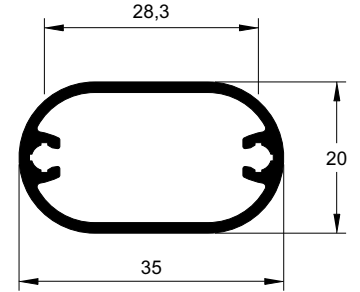

CG-087G
0,427 kg/m

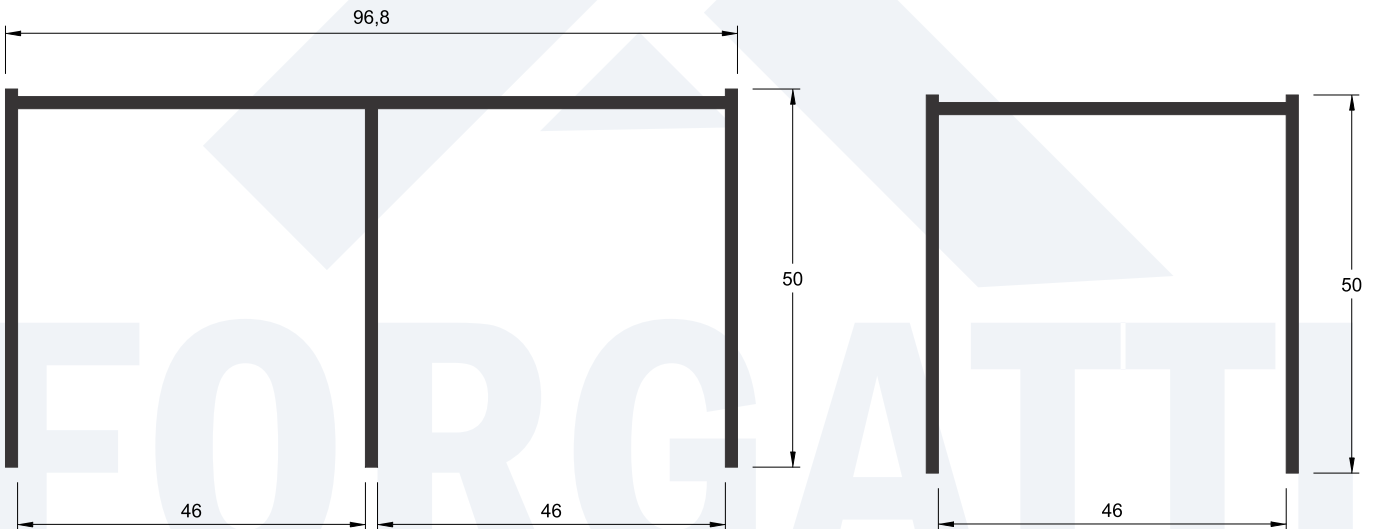

E-363
1,043 kg/m

E-362
0,636 kg/m

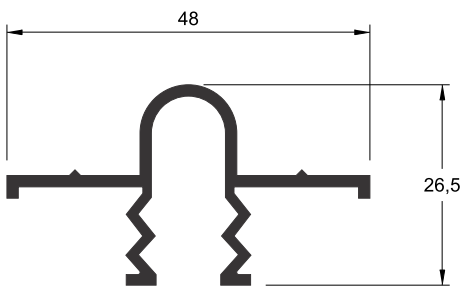

E-364
0,499 kg/m

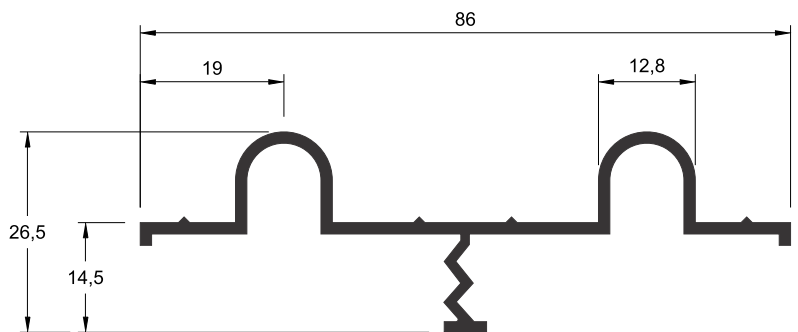

E-365
0,656 kg/m

Linha Convencional

Tubos e Trilhos

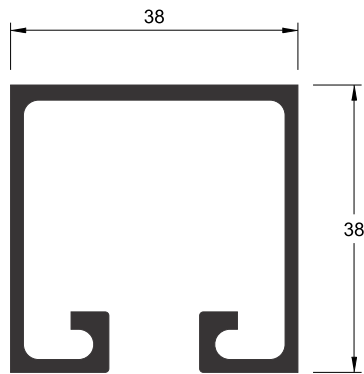

U-990
0,653 kg/m

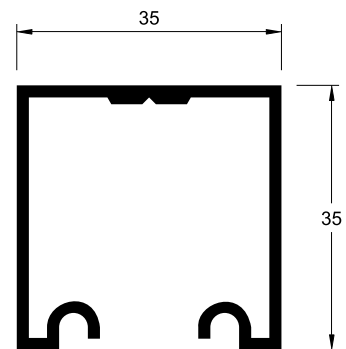

U-1098
0,494 kg/m

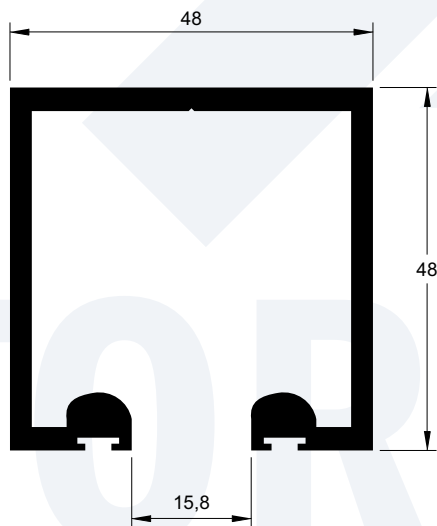

U-4848
1,308 kg/m

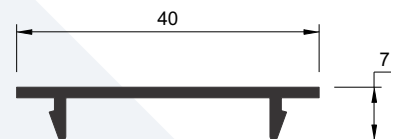

U-531
0,170 kg/m

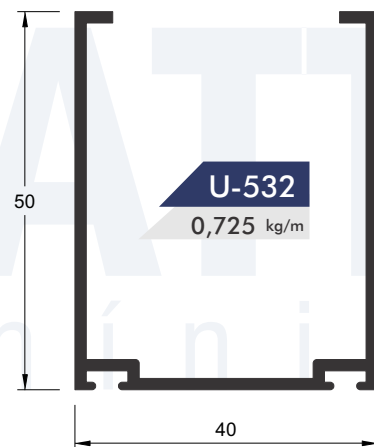

U-532
0,725 kg/m

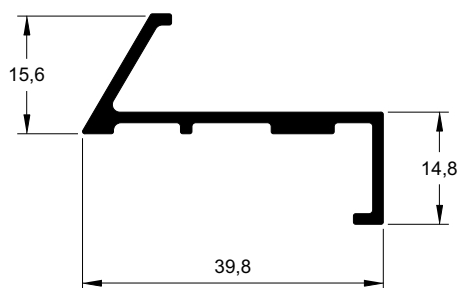

Z-033
0,350 kg/m

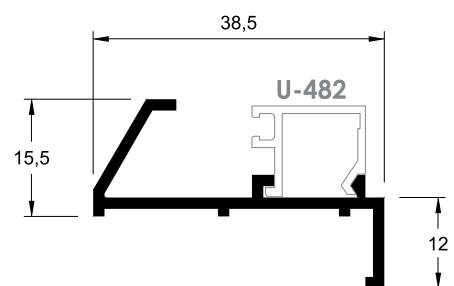

Z-063
0,325 kg/m

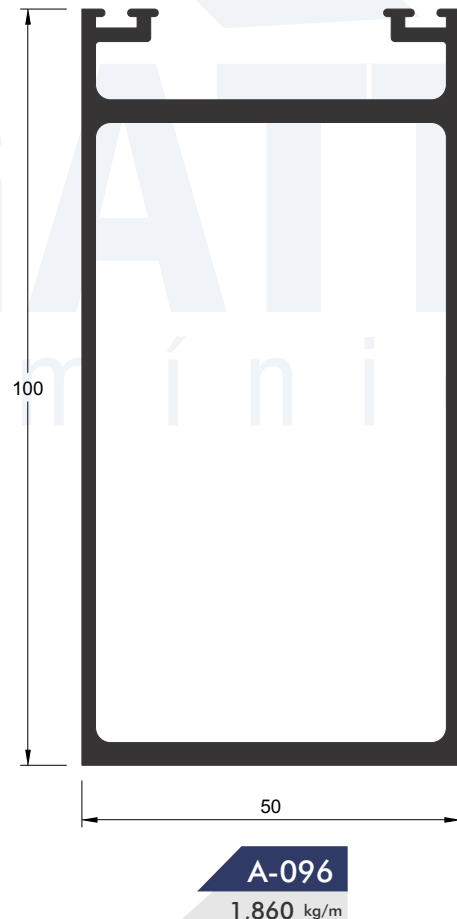
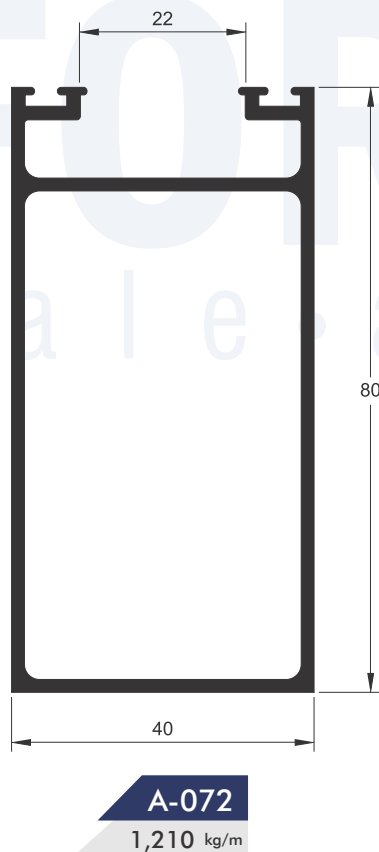
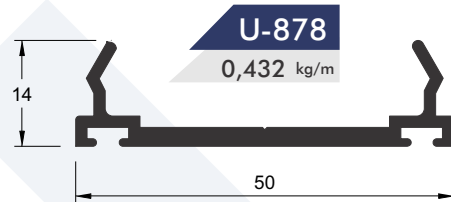
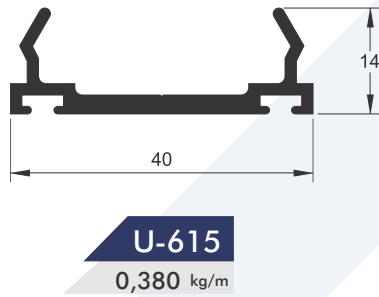
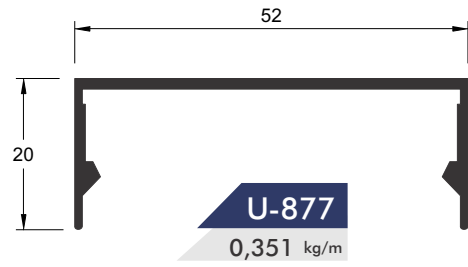
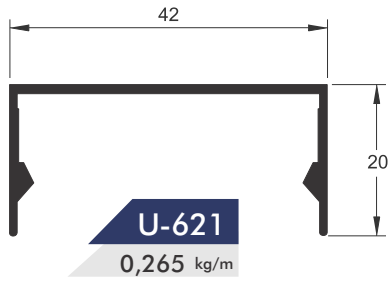

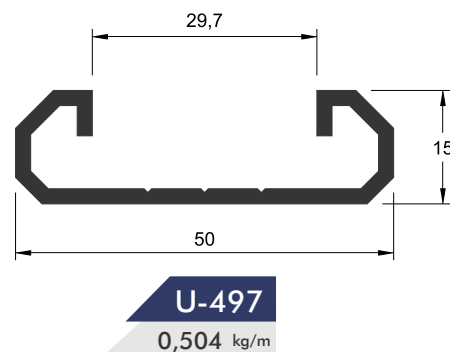
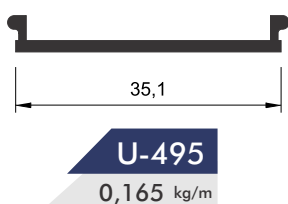
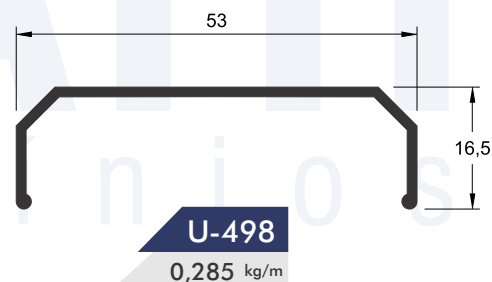
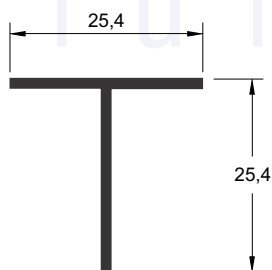
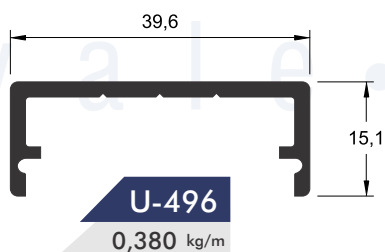
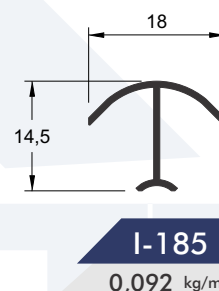
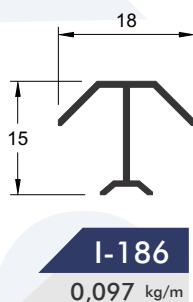
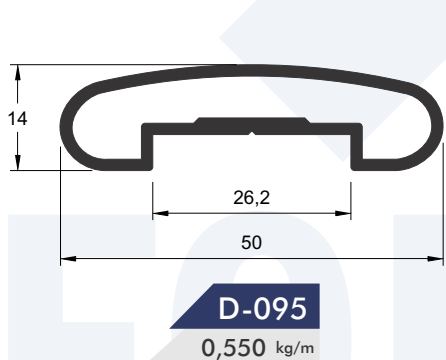
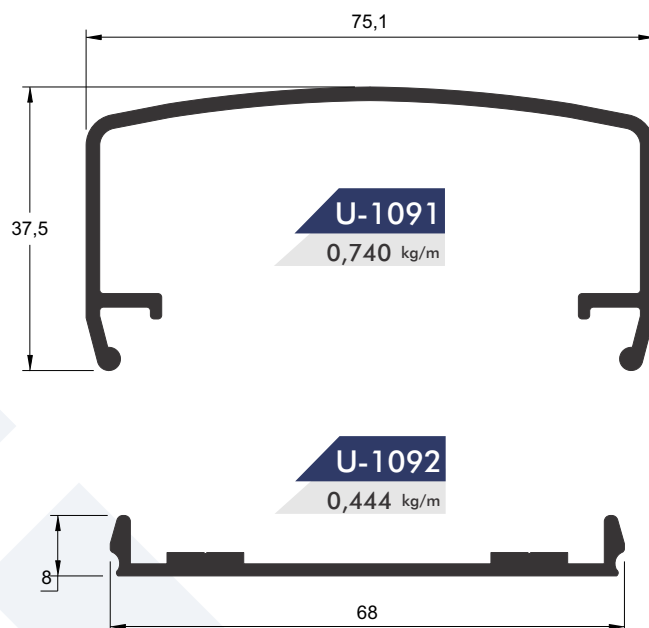
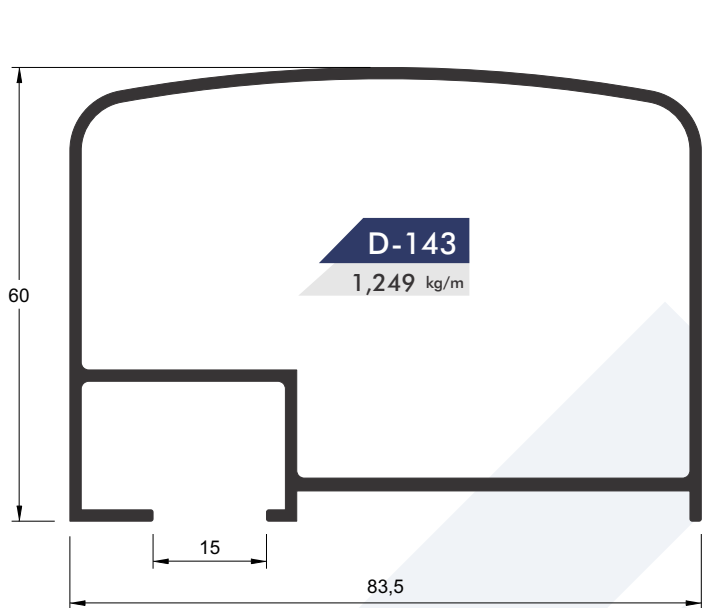

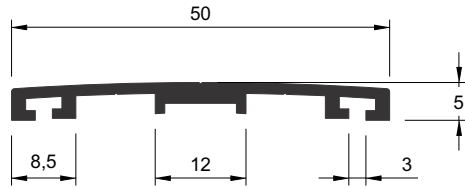

POLI-001

0,278 kg/m

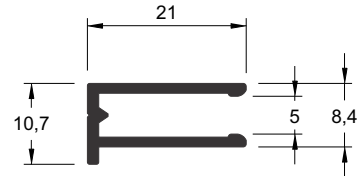

POLI-002

0,171 kg/m



POLI-003

0,136 kg/m

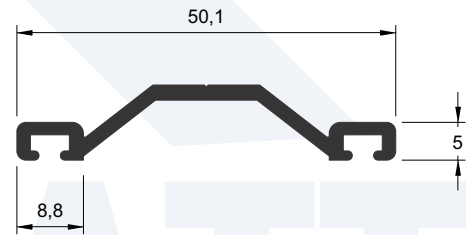

POLI-004

0,311 kg/m

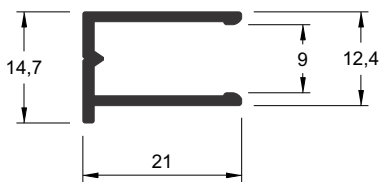

POLI-010

0,184 kg/m

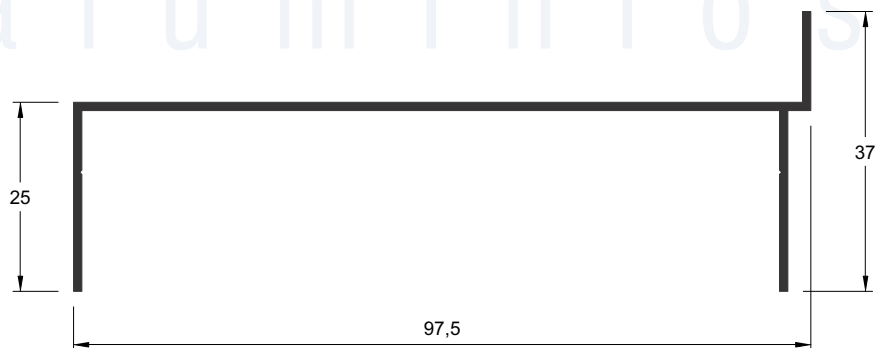

PN-2212

0,427 kg/m

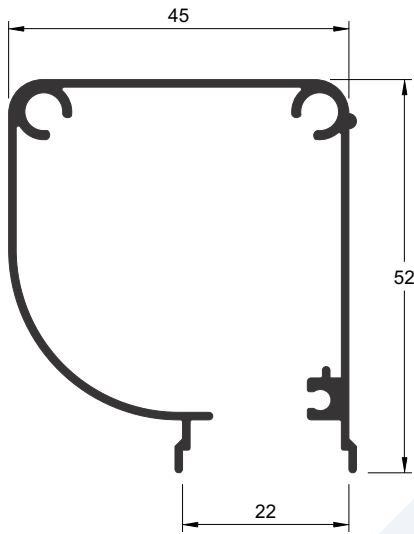

TM 1500
0,590 kg/m

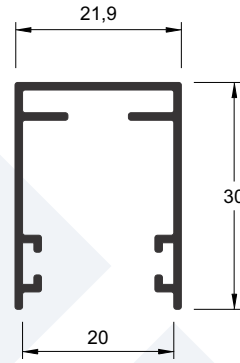

TM 1857
0,290 kg/m

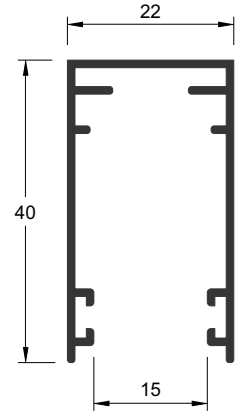

TM 1498
0,347 kg/m

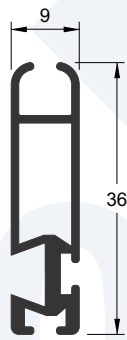

TM 1499
0,320 kg/m

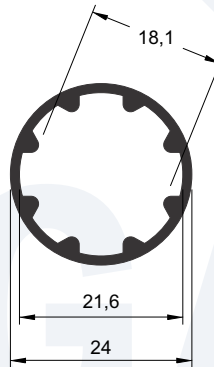

TM 1497
0,320 kg/m

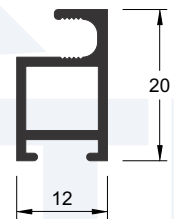

A-058
0,203 kg/m

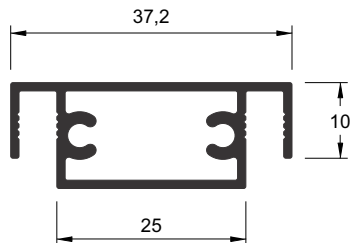

TM 1440
0,379 kg/m

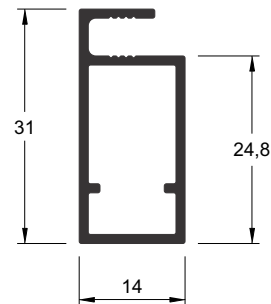

TM 1434
0,295 kg/m

Linha Convencional

Tela Mosquiteira

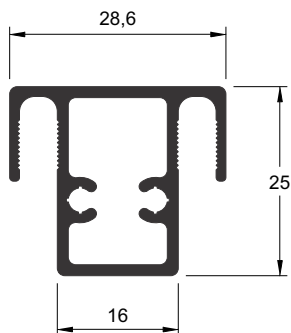

P-256
0,497 kg/m

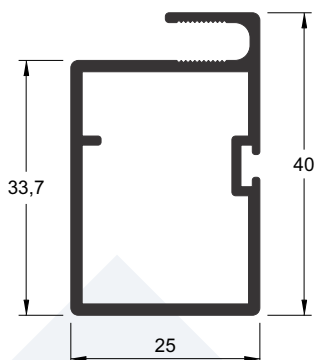

P-227
0,535 kg/m

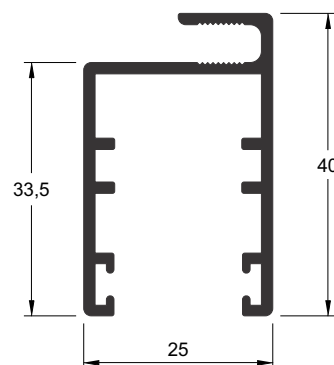

Y-312
0,516 kg/m

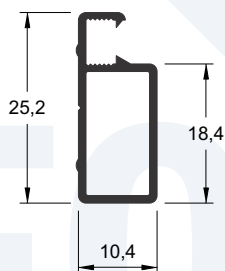

TM 1712
0,176 kg/m

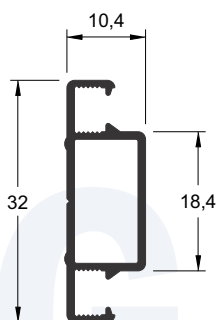

TM 1858
0,214 kg/m

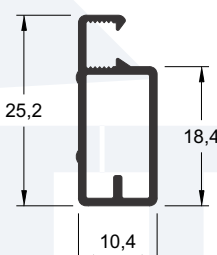

P-027
0,198 kg/m

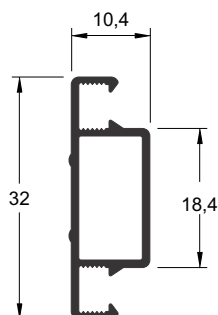

TM 5486
0,212 kg/m

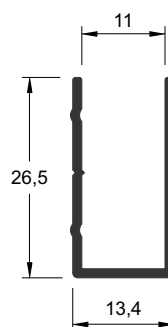

TM 2070
0,208 kg/m

**PERFIS BOX LISO E FRISADO
PERFIS PARA ESQUADRIAS, FACHADAS E OUTROS
CHAPA EM ALUMÍNIO / ACM
CHAPAS, TELHAS E VENEZIANA EM POLICARBONATO**

**KIT DE FERRAGENS PARA PORTÕES BASCULANTE
ACESSÓRIOS * COMPONENTES
ESCOVAS DE VEDAÇÃO * GUARNIÇÕES EM EPDM
PARAFUSOS * BUCHAS * REBITES
KITS PARA BOX**



Rua Koichi Matsumura, 132 - Jardim América - São José dos Campos / SP
CEP 12235-180 - TEL (12) 3931-3937
e-mail: forgattivale@uol.com.br - www.forgatti.com.br